

STEINBERG



Waschtisch-Einhebelmischbatterie

Art.Nr.100 1750 S

Installation

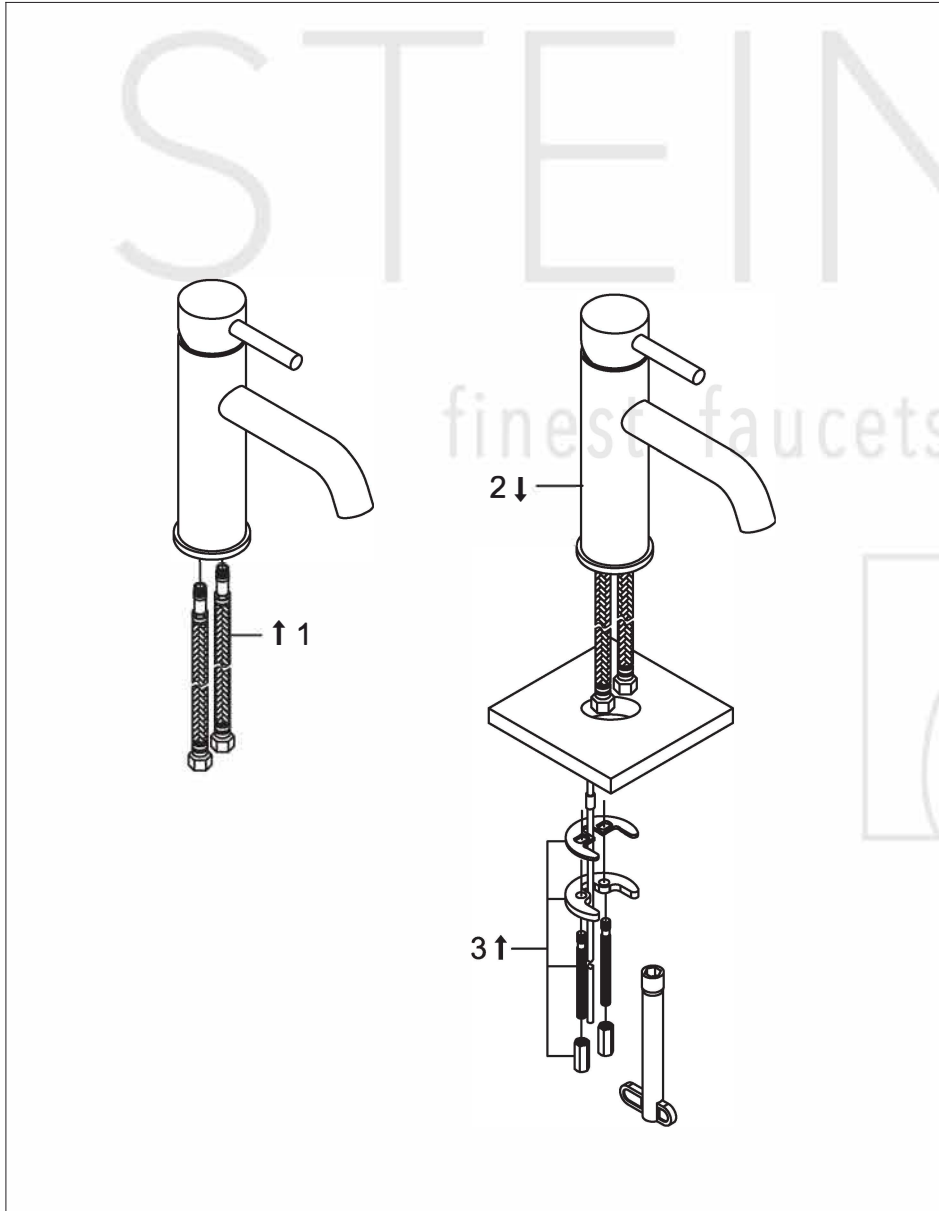

Technische Zeichnung

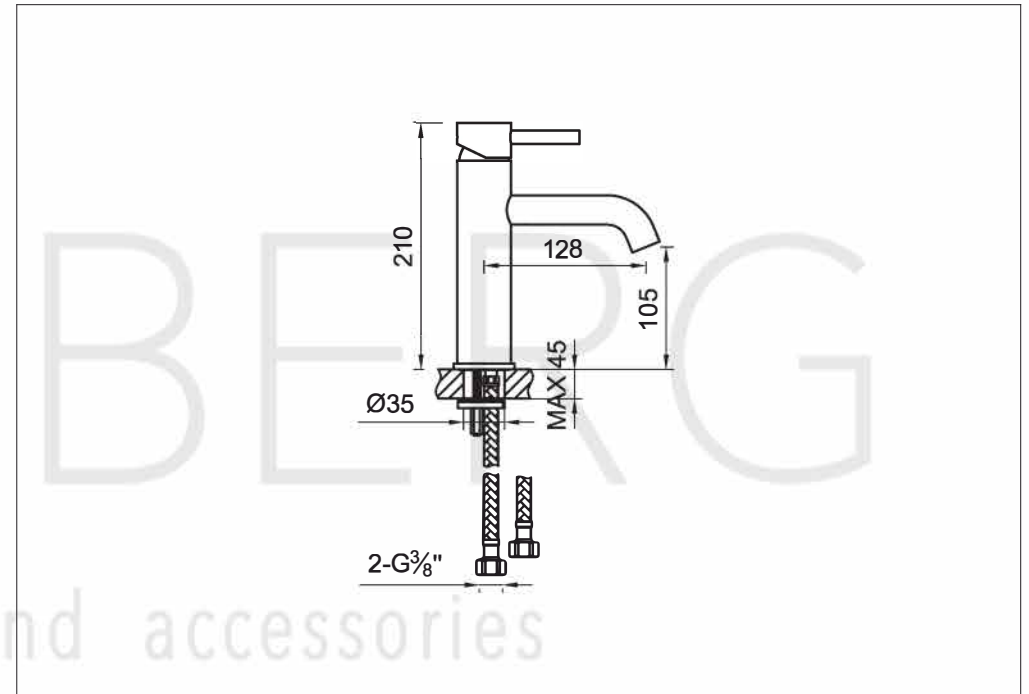

Explosionszeichnung

