

Theoretic Mass(kg)		Revision	
Surface Area(dm ²)		A4	

Thread	Hole	Shaft

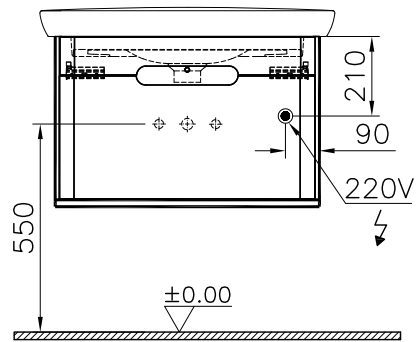
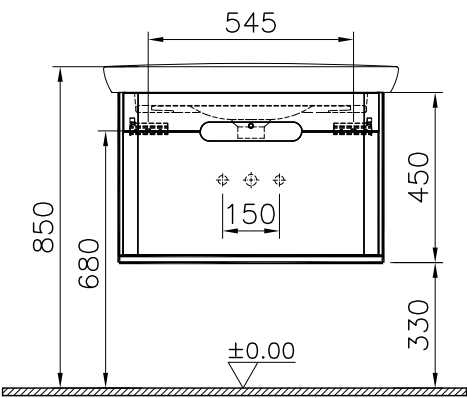
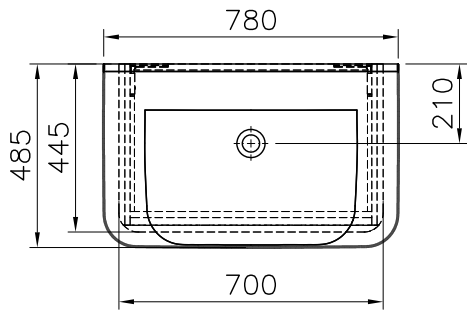

1	1	Washbasin Unit	60813		
item	Quantity	Part Name	Drawing No	Material	Material Class
		Series	Material	Material Class	
		SENTO	Washbasin Unit		
Drawn By	Controlled By	Approved By	Date	Drawing No	Scale
G.GULTER	M.EVCI	H.ALACA	16.11.2016	60813	1/20

R.S	Description	Date	NAME

This drawing can only be used for the intended purposes. Unauthorized copying is strictly prohibited.

VitrA® ART^{EM}A