

AXOR

DE / Gebrauchsanleitung / Montageanleitung	02
FR / Mode d'emploi / Instructions de montage	03
EN / Instructions for use / assembly instructions	04
IT / Istruzioni per l'uso / Istruzioni per l'installazione	05
ES / Modo de empleo / Instrucciones de montaje	06
NL / Gebruiksaanwijzing / Handleiding	07
DK / Brugsanvisning / Monteringsvejledning	08
PT / Instruções para uso / Manual de Instalação	09
PL / Instrukcja obsługi / Instrukcja montażu	10
CS / Návod k použití / Montážní návod	11
SK / Návod na použitie / Montážny návod	12
ZH / 用户手册 / 组装说明	13
RU / Руководство пользователя / Инструкция по монтажу	14
FI / Käyttöohje / Asennusohje	15
SV / Bruksanvisning / Monteringsanvisning	16
LT / Vartotojo instrukcija / Montavimo instrukcijos	17
HR / Upute za uporabu / Uputstva za instalaciju	18
TR / Kullanım kılavuzu / Montaj kılavuzu	19
RO / Manual de utilizare / Instrucțiuni de montare	20
EL / Οδηγίες χρήσης / Οδηγία συναρμολόγησης	21
SL / Navodilo za uporabo / Navodila za montažo	22
ET / Kasutusjuhend / Paigaldusjuhend	23
LV / Lietošanas pamācība / Montāžas instrukcija	24
SR / Uputstvo za upotrebu / Uputstvo za montažu	25
NO / Bruksanvisning / Montasjeveiledning	26
BG / Инструкция за употреба / Ръководство за монтаж	27
SQ / Udhëzuesi i përdorimit / Udhëzime rreth montimit	28
AR / تعليمات التجميع / دليل الاستخدام	29
HU / Használati útmutató / Szerelési útmutató	30

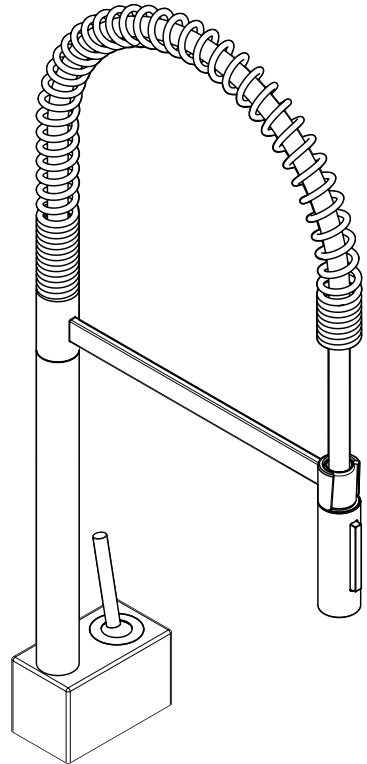

AXOR Starck Semi-Pro
10820000

AXOR Starck Semi-Pro Eco
12803000

INSTALLATION

⚠ SICHERHEITSHINWEISE

- ⚠ Bei der Montage müssen zur Vermeidung von Quetsch- und Schnittverletzungen Handschuhe getragen werden.
- ⚠ Große Druckunterschiede zwischen den Kalt- und Warmwasseranschlüssen müssen ausgeglichen werden.

MONTAGEHINWEISE



- / Vor der Montage muss das Produkt auf Transportschäden untersucht werden. Nach dem Einbau werden keine Transport- oder Oberflächenschäden anerkannt.
- / Die Leitungen und die Armatur müssen nach den gültigen Normen montiert, gespült und geprüft werden.
- / Die in den Ländern jeweils gültigen Installationsrichtlinien sind einzuhalten.
- / 12803000: Die Armatur kann nicht in Verbindung mit einem Durchlauferhitzer verwendet werden.

TECHNISCHE DATEN

Betriebsdruck:	max. 1 MPa
Empfohlener Betriebsdruck:	0,1 - 0,5 MPa
Prüfdruck:	1,6 MPa (1 MPa = 10 bar = 147 PSI)
Heißwassertemperatur:	max. 70°C
Empfohlene Heißwassertemperatur:	65°C
Thermische Desinfektion:	max. 70°C/4 min

Das Produkt ist ausschließlich für Trinkwasser konzipiert!

SYMBOLERKLÄRUNG

-  Kein essigsäurehaltiges Silikon verwenden!
-  MASSE (siehe Seite 35)
-  DURCHFLUSSDIAGRAMM (siehe Seite 36)
-  REINIGUNG (siehe Seite 38)
-  WARTUNG (siehe Seite 39)
-  Rückflussverhinderer müssen gemäß DIN EN 1717 regelmäßig in Übereinstimmung mit nationalen oder regionalen Bestimmungen auf ihre Funktion geprüft werden (mindestens einmal jährlich).
-  SERVICETEILE (siehe Seite 40)
-  SONDERZUBEHÖR (nicht im Lieferumfang enthalten)
-  / Ausgleichsset #97474000 (siehe Seite 32)
-  / Adapter (G½/G¾) #93395000 (siehe Seite 41)
-  BEDIENUNG (siehe Seite 37)
-  Hansgrohe empfiehlt, morgens oder nach längeren Stagnationszeiten den ersten halben Liter nicht als Trinkwasser zu verwenden.
-  PRÜFZEICHEN (siehe Seite 42)

STÖRUNG**URSACHE****ABHILFE**

/ Armatur schwergängig	/ Kartusche defekt, verkalkt	/ Kartusche austauschen
/ Armatur tropft	/ Kartusche defekt	/ Kartusche austauschen
/ Wasseraustritt am Befestigungsschaft	/ Anschlusschläuche nicht ganz in den Grundkörper eingeschraubt	/ Anschlusschläuche von Hand festziehen
	/ O-Ring am Anschluss Schlauch defekt	/ O-Ring austauschen
/ Zu niedrige Warmwassertemperatur	/ Warmwasserbegrenzung falsch eingestellt	/ Warmwasserbegrenzung einstellen

△ CONSIGNES DE SÉCURITÉ

- △ Lors du montage, porter des gants de protection pour éviter toute blessure par écrasement ou coupure.
- △ Il est conseillé d'équilibrer les pressions de l'eau chaude et froide.

INSTRUCTIONS POUR LE MONTAGE

- / Avant son montage, s'assurer que le produit n'a subi aucun dommage pendant le transport. Après le montage, tout dommage de transport ou de surface ne pourra pas être reconnu.
- / Les conduites et la robinetterie doivent être montés, rincés et contrôlés selon les normes en vigueur.
- / Les directives d'installation en vigueur dans le pays concerné doivent être respectées.
- / 12803000: Le robinet ne fonctionne pas avec une production d'eau chaude instantanée.

INFORMATIONS TECHNIQUES

Pression de service autorisée:	max. 1 MPa
Pression de service conseillée:	0,1 - 0,5 MPa
Pression maximum de contrôle:	1,6 MPa (1 MPa = 10 bar = 147 PSI)
Température d'eau chaude:	max. 70°C
Température recommandée:	65°C
Désinfection thermique:	max. 70°C / 4 min

Le produit est exclusivement conçu pour de l'eau potable!

DESCRIPTION DU SYMBOLE



Ne pas utiliser de silicone contenant de l'acide acétique!



DIMENSIONS (voir pages 35)



DIAGRAMME DU DÉBIT
(voir pages 36)



NETTOYAGE (voir pages 38)



ENTRETIEN (voir pages 39)

Les clapets anti-retour doivent être examinés régulièrement conformément à la norme EN 1717 ou conformément aux dispositions nationales ou régionales quant à leur fonction (au moins une fois par an).



PIÈCES DÉTACHÉES (voir pages 40)

ACCESSOIRES EN OPTION
(ne fait pas partie de la fourniture)



/ Set d'égalisation #97474000 (voir pages 32)



/ Adaptateur (G $\frac{1}{2}$ / G $\frac{3}{4}$) #93395000
(voir pages 41)



INSTRUCTIONS DE SERVICE
(voir pages 37)

Hansgrohe recommande de ne pas utiliser le premier demi-litre le matin ou après une période de stagnation prolongée.



CLASSIFICATION ACOUSTIQUE
ET DÉBIT (voir pages 42)

DYSFONCTIONNEMENT

ORIGINE

SOLUTION

/ Dureté de fonctionnement	/ Cartouche défectueuse, entartrée	/ Changer la cartouche
/ Le mitigeur goutte	/ Cartouche défectueuse	/ Changer la cartouche
/ Fuite à la fixation sous le mitigeur	/ Les flexibles de raccordement ne sont pas correctement visser dans le corps.	/ Resserrer le flexible à la main.
	/ Joint torique sous le flexible de raccords défectueux	/ Changer le joint torique
/ Température d'eau chaude trop basse, pas d'eau froide	/ Limiteur de température mal positionné	/ Positionner le limiteur de température

⚠ SAFETY NOTES

- ⚠ Gloves should be worn during installation to prevent crushing and cutting injuries.
- ⚠ The hot and cold supplies must be of equal pressures.









INSTALLATION INSTRUCTIONS

- / Prior to installation, inspect the product for transport damages. After it has been installed, no transport or surface damage will be honoured.
- / The pipes and the fixture must be installed, flushed and tested as per the applicable standards.
- / The plumbing codes applicable in the respective countries must be observed.
- / 12803000: The mixer can not used together with a continuous flow water heater.

TECHNICAL DATA

Operating pressure:	max. 1 MPa
Recommended operating pressure:	0,1 - 0,5 MPa
Test pressure:	1,6 MPa
	(1 MPa = 10 bar = 147 PSI)
Hot water temperature:	max. 70°C
Recommended hot water temp.:	65°C
Thermal disinfection:	max. 70°C/4 min
The product is exclusively designed for drinking water!	

SYMBOL DESCRIPTION

-  Do not use silicone containing acetic acid!
-  DIMENSIONS (see page 35)
-  FLOW DIAGRAM (see page 36)
-  CLEANING (see page 38)
-  MAINTENANCE (see page 39)
The check valves must be checked regularly according to DIN EN 1717 in accordance with national or regional regulations (at least once a year).
-  SPARE PARTS (see page 40)
-  SPECIAL ACCESSORIES (order as an extra)
 - / levelling set #97474000 (see page 32)
 - / Adapter (G½/G¾) #93395000 (see page 41)
-  OPERATION (see page 37)
Hansgrohe recommends not to use as drinking water the first half liter of water drawn in the morning or after a prolonged period of non-use.
-  TEST CERTIFICATE (see page 42)

FAULT

CAUSE

REMEDY

/ Mixer stiff	/ Cartridge defective, calcified	/ Exchange cartridge
/ Mixer dripping	/ Cartridge defective	/ Exchange cartridge
/ Water escaping at the threaded base	/ connection hoses not completely screwed into basic body	/ Tighten connection hoses by hand
	/ O-ring at the connection hose defective.	/ Exchange O-ring
/ Hot water temperature too low	/ Hot water limiter incorrectly set	/ Set hot water limiter



△ INDICAZIONI SULLA SICUREZZA

- △ Durante il montaggio, per evitare ferite da schiacciamento e da taglio bisogna indossare guanti protettivi.
- △ Attenzione! Compensare le differenze di pressione tra i collegamenti dell'acqua fredda e dell'acqua calda.

ISTRUZIONI PER IL MONTAGGIO

- / Prima del montaggio è necessario controllare che non ci siano stati danni durante il trasporto. Una volta eseguito il montaggio, non verranno riconosciuti eventuali danni di trasporto o delle superfici.
- / Montare, lavare e controllare tubature e rubinetteria rispettando le norme correnti.
- / Vanno rispettate le direttive di installazione nazionali vigenti nel rispettivo paese.
- / 12803000: Il rubinetto non può essere utilizzato insieme ad uno scalda-acqua istantaneo.

DATI TECNICI

Pressione d'uso:	max. 1 MPa
Pressione d'uso consigliata:	0,1 - 0,5 MPa
Pressione di prova:	1,6 MPa
	(1 MPa = 10 bar = 147 PSI)
Temperatura dell'acqua calda:	max. 70°C
Temp. dell'acqua calda consigliata:	65°C
Disinfezione termica:	max. 70°C / 4 min

Il prodotto è concepito esclusivamente per acqua potabile!

DESCRIZIONE SIMBOLO

-  Non utilizzare silicone contenente acido acetico!
-  INGOMBRI (vedi pagg. 35)
-  DIAGRAMMA FLUSSO (vedi pagg. 36)
-  PULITURA (vedi pagg. 38)
-  MANUTENZIONE (vedi pagg. 39)
- La valvola di non ritorno deve essere controllata regolarmente come da DIN EN 1717, secondo le normative nazionali e regionali (almeno una volta all'anno).
-  PARTI DI RICAMBIO (vedi pagg. 40)
- ACCESSORI SPECIALI (non contenuto nel volume di fornitura)
-  / Elemento per la regolazione in altezza #97474000 (vedi pagg. 32)
-  / Adattatore (G $\frac{1}{2}$ /G $\frac{3}{4}$) #93395000 (vedi pagg. 41)
-  PROCEDURA (vedi pagg. 37)
- Hansgrohe raccomanda, di mattina oppure dopo lunghi tempi di stagnazione, di non utilizzare il primo mezzo litro come acqua potabile.
-  SEGNO DI VERIFICA (vedi pagg. 42)

PROBLEMA	POSSIBILE CAUSA	RIMEDIO
/ Miscelatore duro	/ Cartuccia difettosa	/ Sostituire la cartuccia
/ Miscelatore gocciola	/ Cartuccia difettosa	/ Sostituire la cartuccia
/ Perdita di acqua al set di fissaggio	/ I raccordi dei flessibili avvitati male nel corpo incasso	/ Avvitare i raccordi flessibili a mano
	/ O-ring al raccordo flessibile difettoso	/ Sostituire l'o-ring
/ Temperatura dell'acqua calda	/ Limitazione dell'acqua calda regolata male	/ Regolare la limitazione dell'acqua calda



△ INDICACIONES DE SEGURIDAD

- △ Durante el montaje deben utilizarse guantes para evitar heridas por aplastamiento o corte.
- △ Grandes diferencias de presión en servicio entre agua fría y agua caliente deben equilibrarse.

INDICACIONES PARA EL MONTAJE

- / Antes del montaje se debe examinar el producto contra daños de transporte. Después de la instalación no se reconoce ningún daño de transporte o de superficie.
- / Los conductos y la grifería deben montarse, lavarse y comprobarse según las normas vigentes.
- / Es obligatorio el cumplimiento de las directrices de instalación vigentes en el país respectivo.
- / 12803000: Este grifo no es apto en combinación con un calentador continuo.

DATOS TÉCNICOS

Presión en servicio:	max. 1 MPa
Presión recomendada en servicio:	0,1 - 0,5 MPa
Presión de prueba:	1,6 MPa (1 MPa = 10 bar = 147 PSI)
Temperatura del agua caliente:	max. 70°C
Temp. recomendada del agua caliente:	65°C
Desinfección térmica:	max. 70°C / 4 min

El producto ha sido concebido exclusivamente para agua potable.

DESCRIPCIÓN DE SÍMBOLOS

-  No utilizar silicona que contiene ácido acético
-  DIMENSIONES (ver página 35)
-  DIAGRAMA DE CIRCULACIÓN (ver página 36)
-  LIMPIAR (ver página 38)
-  MANTENIMIENTO (ver página 39)
- Las válvulas anti-retorno tienen que ser controladas regularmente según la norma DIN EN 1717, en acuerdo con las regulaciones nacionales o regionales (una vez al año, por lo menos).
-  REPUESTOS (ver página 40)
- OPCIONAL (no incluido en el suministro)
-  / set de nivelación #97474000 (ver página 32)
-  / Adaptador (G $\frac{1}{2}$ /G $\frac{3}{4}$) #93395000 (ver página 41)
-  MANEJO (ver página 37)
- Hansgrohe recomienda no utilizar el primer medio litro como agua potable por las mañanas o tras un largo periodo de inactividad.
-  MARCA DE VERIFICACIÓN (ver página 42)

PROBLEMA	CAUSA	SOLUCIÓN
/ Manecilla va dura	/ cartucho dañado	/ cambiar el cartucho
/ Grifo pierde agua	/ cartucho dañado	/ cambiar el cartucho
/ Pérdida de agua en el set de fijación	/ Conexión flexible mal atornillada al cuerpo del caño.	/ Apretar a mano la conexión flexible
	/ Daños en la junta de la conexión flexible	/ cambiar juntas
/ Temperatura del agua caliente demasiado baja	/ tope de agua caliente mal	/ ajustar tope

△ VEILIGHEIDSinSTRUCTIES

- △ Bij de montage moeten ter voorkoming van knel- en snijwonden handschoenen worden gedragen.
- △ Grote drukverschillen tussen de koud- en warmwater-toevoer dienen vermeden te worden.

MONTAGE-INSTRUCTIES

- / Vóór de montage moet het product gecontroleerd worden op transportschade. Na de inbouw wordt geen transport- of oppervlakteschade meer aanvaard.
- / De leidingen en armaturen moeten gemonteerd, gespoeld en gecontroleerd worden volgens de geldige normen.
- / De in de overeenkomstige landen geldende installatierichtlijnen moeten nageleefd worden.
- / 12803000: Het artikel kan niet in combinatie met een doorstroomtoestel toegepast worden.

TECHNISCHE GEGEVENS

Werkdruk: max.	max. 1 MPa
Aanbevolen werkdruk:	0,1 - 0,5 MPa
Getest bij:	1,6 MPa
	(1 MPa = 10 bar = 147 PSI)
Temperatuur warm water:	max. 70°C
Aanbevolen warm water temp.:	65°C
Thermische desinfectie:	max. 70°C / 4 min

Het product is uitsluitend ontworpen voor drinkwater!

SYMBOOLBESCHRIJVING

-  Gebruik geen zuurhoudende siliconel
-  MATEN (zie blz. 35)
-  DOORSTROOMDIAGRAM (zie blz. 36)
-  REINIGEN (zie blz. 38)
-  ONDERHOUD (zie blz. 39)
- Keerkleppen moeten volgens DIN EN 1717 regelmatig en volgens plaatselijk geldende eisen op het functioneren gecontroleerd worden. (Tenminste een keer per jaar)
-  SERVICE ONDERDELEN (zie blz. 40)
- TOEBEHOREN (behoort niet tot het leveringspakket)
-  / nivelleerset #97474000 (zie blz. 32)
-  / Adapter (G $\frac{1}{2}$ /G $\frac{3}{4}$) #93395000 (zie blz. 41)
-  BEDIENING (zie blz. 37)
- Hansgrohe raadt aan om 's morgens na langere stagnatietijden de eerste halve liter niet als drinkwater te gebruiken.
-  KEURMERK (zie blz. 42)

STORING

- / Bediening zwaar
- / Mengkraan lekt
- / Lekkage op montageschacht
- / Temperatuur van warm water te laag

OORZAAK

- / Kardoes defect of verkalkt
- / Kardoes defect
- / Aansluitslangen niet geheel in kraanhuus vastgedraaid
- / O-ring van aansluit slang defect
- / Heetwaterbegrenzer verkeerd ingesteld

OPLOSSING

- / Kardoes uitwisselen
- / Kardoes uitwisselen
- / Aansluitslangen handvast aandraaien
- / O-ring uitwisselen
- / Heetwaterbegrenzer instellen



⚠ SIKKERHEDSANVISNINGER

- ⚠ Ved monteringen skal der bruges handsker for at undgå kvæstelser og snitsår.
- ⚠ Større trykforskelle mellem koldt og varmt vand bør undgås.

MONTERINGSANVISNINGER

- / Før monteringen skal produktet kontrolleres for transportskader. Efter monteringen godkendes transportskader eller skader på overfladen ikke længere.
- / Ledningerne og armaturerne skal monteres, skylles og kontrolleres iht. de gældende standarder.
- / Installationsbestemmelserne, der gælder i det enkelte land, skal overholdes.
- / 12803000: Armaturet bør ikke anvendes i forbindelse med en gennemstrømningsvandvarmer.

TEKNISKE DATA

Driftstryk:	max. 1 MPa
Anbefalet driftstryk:	0,1 - 0,5 MPa
Prøvetryk:	1,6 MPa
	(1 MPa = 10 bar = 147 PSI)
Varmtvandstemperatur:	max. 70°C
Anbefalet varmtvandstemperatur:	65°C
Termisk desinfektion:	max. 70°C / 4 min
Produktet er udelukkende beregnet til drikkevand!	

SYMBOLBESKRIVELSE

-  Der må ikke benyttes eddikesyreholdig silikone!
-  MÅLENE (se s. 35)
-  GENNEMSTRØMNINGSDIAGRAM (se s. 36)
-  RENGØRING (se s. 38)
-  SERVICE (se s. 39)
-  Ifølge DIN EN 1717 skal gennemstrømningsbegrænsere i overensstemmelse med nationale regler afprøves regelmæssigt (mindst en gang om året).
-  RESERVEDELE (se s. 40)
-  SPECIALTILBEHØR (ikke med i leveringsomfang)
-  / Nivelleringsæt #97474000 (se s. 32)
-  / Adapter (G $\frac{1}{2}$ / G $\frac{3}{4}$) #93395000 (se s. 41)
-  BRUGSANVISNING (se s. 37)
-  Hansgrohe anbefaler at den første halve liter om morgenen eller efter længere stagneringstider ikke anvendes som drikkevand.
-  GODKENDELSE (se s. 42)

FEJL	ÅRSAG	HJÆLP
/ Grebet går trægt	/ Kartusche defekt, tilkalket	/ Udskift kartusche
/ Armaturet drypper	/ Defekt kartusche	/ Udskift kartusche
/ Armaturet er utæt ved befæstelsesdelene	/ Tilslutningsslangerne er ikke skruet korrekt op i armaturet.	/ Med håndkraft skures tilslutningsslangen strammere på.
	/ Defekt o-ring på tilslutningsslange	/ Udskift o-ring
/ For lav varmtvands-temperatur	/ Varmtvandsbegrænsningen er forkert indstillet	/ Indstil varmtvandsbegrænsningen



⚠ AVISOS DE SEGURANÇA

- ⚠ Durante a montagem devem ser utilizadas luvas de protecção, de modo a evitar ferimentos resultantes de entalamentos e de cortes.
- ⚠ Grandes diferenças entre as pressões das águas quente e fria devem ser compensadas.

AVISOS DE MONTAGEM

- / Antes da montagem deve-se controlar o produto relativamente a danos de transporte. Após a montagem não são aceites quaisquer danos de transporte ou de superfície.
- / As tubagens e a torneira têm que ser montadas, enxaguadas e verificadas de acordo com as normas em vigor.
- / A prescrições de instalação válidas nos respetivos países devem ser respeitadas.
- / 12803000: A misturadora não pode ser utilizada com esquentadores instantâneos ou caldeira.

DADOS TÉCNICOS

Pressão de funcionamento:	max. 1 MPa
Pressão de func. recomendada:	0,1 - 0,5 MPa
Pressão testada:	1,6 MPa
	(1 MPa = 10 bar = 147 PSI)
Temperatura da água quente:	max. 70°C
Temp. água quente recomendada:	65°C
Desinfecção térmica:	max. 70°C/4 min

Este produto foi única e exclusivamente concebido para água potável!

DESCRIÇÃO DO SÍMBOLO



Não utilizar silicone que contenha ácido acético!



MEDIDAS (ver página 35)



FLUXOGRAMA (ver página 36)

LIMPEZA (ver página 38)



MANUTENÇÃO (ver página 39)

As válvulas anti-retorno devem ser verificadas regularmente de acordo com a DIN EN 1717 segundo os regulamentos nacionais ou regionais (pelo menos uma vez por ano).



PEÇAS DE SUBSTITUIÇÃO (ver página 40)

ACESSÓRIOS ESPECIAIS (não incluído no volume de fornecimento)



/ conjunto de nivelamento #97474000 (ver página 32)



/ Adaptador (G $\frac{1}{2}$ /G $\frac{3}{4}$) #93395000 (ver página 41)



FUNCIONAMENTO (ver página 37)

A Hansgrohe recomenda a não utilização do primeiro meio litro de água, de manhã ou após longas paragens, para fins de consumo.



MARCA DE CONTROLO (ver página 42)

FALHA	CAUSA	SOLUÇÃO
/ Misturadora perra	/ Cartucho defeituoso, calcificado	/ Substituir o cartucho
/ Misturadora a pingar	/ Cartucho defeituoso	/ Substituir o cartucho
/ Perde água pela base roscada	/ Tubos de ligação não estão completamente enroscados	/ Apertar os tubos de ligação à mão
	/ O-ring dos tubo de ligação defeituoso	/ Trocar o-ring
/ Temperatura da água quente muito baixa	/ O limitador de temperatura está incorretamente colocado	/ Regular o limitador de temperatura



△ WSKAZÓWKI BEZPIECZEŃSTWA

- △ Aby uniknąć zranień na skutek zgniecenia lub przecięcia, podczas montażu należy nosić rękawice ochronne.
- △ Znaczne różnice ciśnień na dopływach ciepłej i zimnej wody muszą zostać wyrównane.











WSKAZÓWKI MONTAŻOWE

- / Przed montażem należy skontrolować produkt pod kątem szkód transportowych. Po montażu nie widać żadnych szkód transportowych ani szkód na powierzchni.
- / Przewody i armatura muszą być montowane, płukane i kontrolowane według obowiązujących norm.
- / Należy przestrzegać wytycznych instalacyjnych obowiązujących w danym kraju.
- / 12803000: Armatura nie może współpracować z przepływowymi podgrzewaczami wody.

DANE TECHNICZNE

Ciśnienie robocze:	maks. 1 MPa
Zalecane ciśnienie robocze:	0,1 - 0,5 MPa
Ciśnienie próbne:	1,6 MPa
	(1 MPa = 10 bary = 147 PSI)
Temperatura wody gorącej:	maks. 70°C
Zalecana temperatura wody gorącej:	65°C
Dezynfekcja termiczna:	maks. 70°C / 4 min
Produkt przeznaczony wyłącznie do wody pitnej!	

OPIS SYMBOLU

-  Nie stosować silikonów zawierających kwas octowy!
-  WYMIARY (patrz strona 35)
-  SCHEMAT PRZEPŁYWU (patrz strona 36)
-  CZYSZCZENIE (patrz strona 38)
-  KONSERWACJA (patrz strona 39)
- Zgodnie z normą DIN EN 1717, krajowymi i miejscowymi przepisami, działanie zabezpieczeń przed przepływem zwrotnym musi być kontrolowane (przynajmniej raz w roku).
-  CZĘŚCI SERWISOWE (patrz strona 40)
- WYPOSAŻENIE SPECJALNE (Nie jest częścią dostawy)
-  / zespół poziomujący #97474000 (patrz strona 32)
-  / Przejściówka (G $\frac{1}{2}$ /G $\frac{3}{4}$) #93395000 (patrz strona 41)
-  OBSŁUGA (patrz strona 37)
- Hansgrohe zaleca, by z rana lub po dłuższym czasie niekorzystania, pierwsze pół litra wody nie używać jako wody pitnej.
-  ZNAK JAKOŚCI (patrz strona 42)

USTERKA	PRZYCZYNA	POMOC
/ Uchwyt armatury pracuje z wysiłkiem	/ Uszkodzony wkład, zakamieniony	/ Wymiana wkładu
/ Armatura cieknie	/ Uszkodzony wkład	/ Wymiana wkładu
/ Wyciek wody przy mocowaniu od dołu	/ Zbyt słabo wkręcone wężyki w korpus / Uszkodzony o-ring przy wężu przyłączeniowym	/ Dokręcić wężyki / Wymienić o-ring
/ Za niska temperatura ciepłej wody	/ Niewłaściwe ustawienie ogranicznik ciepłej wody	/ Ustawić ogranicznik ciepłej wody

△ BEZPEČNOSTNÍ POKYNY

- △ Pro zabránění řezným zraněním a pohmožděninám je nutné při montáži nosit rukavice.
- △ Je nutné vyrovnat velké rozdíly tlaku mezi přípoji studené a teplé vody.

POKYNY K MONTÁŽI











- / Před montáží je třeba produkt zkontrolovat, zda nebyl při transportu poškozen. Po zabudování nebudou uznány žádné škody způsobené transportem nebo poškození povrchu.
- / Vedení a armatura musí být namontovány, propláchnuty a otestovány podle platných norem.
- / Je třeba dodržovat montážní pravidla platné v dané zemi.
- / 12803000: Armatura se nesmí používat v kombinaci s průtokovým ohřívačem.

TECHNICKÉ ÚDAJE

Provozní tlak:	max. 1 MPa
Doporučený provozní tlak:	0,1 - 0,5 MPa
Zkušební tlak:	1,6 MPa (1 MPa = 10 bar = 147 PSI)
Teplota horké vody:	max. 70°C
Doporučená teplota horké vody:	65°C
Teplná dezinfekce:	max. 70°C / 4 min

Výrobky Hansgrohe jsou vhodné pro přímý kontakt s pitnou vodou.

POPIS SYMBOLŮ

-  Nepoužívat silikon s obsahem kyseliny octové!
-  ROZMĚRY (viz strana 35)
-  DIAGRAM PRŮTOKU (viz strana 36)
-  ČIŠTĚNÍ (viz strana 38)
-  ÚDRŽBA (viz strana 39)
-  U zpětných ventilů se musí podle DIN EN 1717 v souladu s národními nebo regionálními předpisy testovat jejich funkčnost (alespoň jednou ročně).
-  SERVISNÍ DÍLY (viz strana 40)
-  ZVLÁŠTNÍ PŘÍSLUŠENSTVÍ (není součástí dodávky)
 - / vyrovnávací sada #97474000 (viz strana 32)
 - / Adaptér (G $\frac{1}{2}$ / G $\frac{3}{4}$) #93395000 (viz strana 41)
-  OVLÁDÁNÍ (viz strana 37)
-  Hansgrohe doporučuje ráno nebo po delších přestávkách nepoužívat prvního půl litru jako pitnou vodu.
-  ZKUŠEBNÍ ZNAČKA (viz strana 42)

PORUCHA

PŘÍČINA

ODSTRANĚNÍ

/ Armatura jde ztěžka	/ Kartuše je vadná, zanesená-vodním kamenem	/ Kartuši vyměnit
/ Armatura odkapává	/ Kartuše je vadná	/ Kartuši vyměnit
/ výstup vody na upevňovacím násadci	/ přípojovací hadice nejsou dostatečně zašroubovány do tělesa	/ přípojovací hadice utáhnout rukou
	/ O-kroužek na přípojovací hadici je defektní	/ vyměnit O-kroužek
/ Nízká teplota teplé vody	/ Špatně nastavená záračka pro teplou vodu	/ Seřídít záračku pro teplou vodu

△ BEZPEČNOSTNÉ POKYNY

- △ Pri montáži musíte nosiť rukavice, aby ste predišli pomliaždeninám a rezným poraneniam.
- △ Veľké rozdiely v tlaku medzi prípojkami studenej a teplej vody musia byť vyrovnané.

POKYNY PRE MONTÁŽ

- / Pred montážou musíte produkt skontrolovať, či nebol počas transportu poškodený. Po zabudovaní nebudú uznané žiadne škody spôsobené transportom alebo poškodenia povrchu.
- / Ledningarna och blandaren måste monteras, spolansigenom och kontrolleras enligt de gällande normerna.
- / Je potrebné dodržiavať smernice o inštalácii, ktoré sú práve teraz platné v krajinách.
- / 12803000: Armatúra sa nesmie používať v kombinácii s prietokovým ohrievačom.

TECHNICKÉ ÚDAJE

Prevádzkový tlak: max. 1 MPa
 Doporučený prevádzkový tlak: 0,1 - 0,5 MPa
 Skúšobný tlak: 1,6 MPa

(1 MPa = 10 bar = 147 PSI)

Teplota teplej vody: max. 70°C
 Doporučená teplota teplej vody: 65°C
 Termická dezinfekcia: max. 70°C / 4 min

Výrobok je koncipovaný výhradne pre pitnú vodu!

POPIS SYMBOLOV



Nepoužívať silikón s obsahom kyseliny octovej!



ROZMERY (viď strana 35)



DIAGRAM PRIETOKU
(viď strana 36)



ČISTENIE (viď strana 38)



ÚDRŽBA (viď strana 39)

Pri spätných ventiloch sa musí podľa DIN EN 1717 v súlade s národnými alebo regionálnymi predpismi testovať ich funkčnosť (aspoň raz ročne).



SERVISNÉ DIELY (viď strana 40)

ZVLÁŠTNE PRÍSLUŠENSTVO
(nie je súčasťou dodávky)



/ zarovnávacía sada #97474000
(viď strana 32)



/ Adaptér (G $\frac{1}{2}$ / G $\frac{3}{4}$) #93395000
(viď strana 41)



OBSLUHA (viď strana 37)

Hansgrohe odporúča ráno a po dlhších dobách odstávky nepoužiť prvého pol litra vody ako pitnú vodu.



OSVEDČENIE O SKÚŠKE
(viď strana 42)

PORUCHA	PRÍČINA	POMOC
/ Armatúra "chodí" ťažko	/ Kartúša je poškodená, vápenaté usadeniny	/ Vymeniť kartušu
/ Z armatúry kvapká voda	/ Kartúša je poškodená	/ Vymeniť kartušu
/ Uhadzanie vode ob prítldilnem nastavku	/ Hadice pripojenia nie sú celkom zaskrutkované do základného telesa	/ Hadice pripojenia dotiahnuť ručne
	/ Chybný O krúžok na pripojovacej hadici	/ Vymeniť O krúžok
/ Nízka teplota teplej vody	/ Nesprávne nastavená záračka na teplú vodu	/ Nastavenie záračky na teplú vodu



△ 安全技巧

- △ 装配时为避免挤压和切割受伤，必须戴上手套。
- △ 冷热水管间过大的压力差必须予以平衡。

安装提示

- / 安装前必须检查产品是否受到运输损害。安装后将不认可运输损害或表面损伤。
- / 管道和阀门必须根据通用标准进行安装、冲洗和检查。
- / 请遵守当地国家现行的安装规定。
- / 12803000: 阀门不可与即热式热水器连接使用。

技术参数

工作压强:	最大 1 MPa
推荐工作压强:	0,1 - 0,5 MPa
测试压强:	1,6 MPa
	(1 MPa = 10 bar = 147 PSI)
热水温度:	最大 70°C
推荐热水温度:	65°C
热力消毒:	最大 70°C / 4 分钟

该产品专为饮用水设计！

符号说明



请勿使用含有乙酸的硅胶！



大小 (参见第页 35)



流量示意图 (参见第页 36)



清洗 (参见第页 38)



保养 (参见第页 39)

单向阀必须在符合国家或当地的法律的情况下按照DIN EN 1717定期检查（至少一年一次）。



备用零件 (参见第页 40)

选装附件 (不在供货范围内)



/ 调平装置 #97474000 (参见第页 32)



/ 转接器 (G½/G¾) #93395000 (参见第页 41)



操作 (参见第页 37)

汉斯格雅建议，清晨或在水流长时间停滞，前半升水不作饮用水使用。



检验标记 (参见第页 42)

问题	原因	补救
/ 龙头不灵活	/ 阀芯损坏，结垢	/ 更换阀芯
/ 龙头滴水	/ 阀芯损坏	/ 更换阀芯
/ 水从螺纹底座中流出	/ 连接软管没有完全旋入基体	/ 用手拧紧连接软管
	/ 连接软管的O形环损坏	/ 更换O形环
/ 热水温度过低	/ 温度限制器设置错误	/ 设置温度限制器

△ УКАЗАНИЯ ПО ТЕХНИКЕ БЕЗОПАСНОСТИ

- △ Во время монтажа следует надеть перчатки во избежание прищемления и порезов.
- △ донного клапа. Перед установкой смесителя необходимо регулировочными кранами выровнять давление холодной и горячей воды при помощи вентилей регулирующих подачу воды в квартиру.

УКАЗАНИЯ ПО МОНТАЖУ

- / Перед монтажом следует проверить изделие на предмет повреждений при перевозке. После монтажа претензии о возмещении ущерба за повреждения при перевозке или повреждения поверхностей не принимаются.
- / Трубы и арматура должны быть установлены, промыты и проверены в соответствии с действующими нормами.
- / Необходимо соблюдать требования по монтажу, действующие в соответствующих странах.
- / 12803000: Применение арматуры при наличии проточного нагревателя не допускается.

ТЕХНИЧЕСКИЕ ДАННЫЕ

Рабочее давление: не более 1 МПа
 Рекомендуемое рабочее давление: 0,1 - 0,5 МПа
 Давление: 1,6 МПа
 (1 МПа = 10 bar = 147 PSI)
 Температура горячей воды: не более 70°C
 Рекомендуемая темп. гор. воды: 65°C
 Термическая дезинфекция: не более 70°C/4 мин
 Изделие предназначено исключительно для питьевой воды!

ОПИСАНИЕ СИМВОЛОВ



Не применяйте силикон, содержащий уксусную кислоту.



РАЗМЕРЫ (см. стр. 35)



СХЕМА ПОТОКА (см. стр. 36)



ОЧИСТКА (см. стр. 38)



ТЕХНИЧЕСКОЕ ОБСЛУЖИВАНИЕ (см. стр. 39)

Защита обратного тока должна регулярно проверяться (минимум один раз в год) по стандарту DIN EN 1717 или в соответствии с национальными или региональными нормативами



КОМПЛЕКТ (см. стр. 40)

СПЕЦИАЛЬНЫЕ ПРИНАДЛЕЖНОСТИ (не включено в объем поставки!)



/ комплект для выравнивания #97474000 (см. стр. 32)



/ Переходник (G $\frac{1}{2}$ /G $\frac{3}{4}$) #93395000 (см. стр. 41)



ЭКСПЛУАТАЦИЯ (см. стр. 37)

Hansgrohe рекомендует по утрам либо после длительного перерыва в использовании не использовать первые поллитра воды для питья.



ЗНАК ТЕХНИЧЕСКОГО КОНТРОЛЯ (см. стр. 42)

НЕИСПРАВНОСТЬ

ПРИЧИНА

УСТРАНЕНИЕ НЕИСПРАВНОСТИ

/ Арматура работает с усилием	/ Картридж неисправен, засорение накипью	/ Замените картридж
/ Арматура протекает	/ Картридж неисправен	/ Замените картридж
/ Выход воды у основания крепления	/ Шланги подключения не полностью завернуты в корпус	/ Затяните шланги подключения вручную
	/ Уплотнительное кольцо круглого сечения на соединительном шланге неисправно	/ Замените уплотнительное кольцо круглого сечения
/ Температура горячей воды слишком низкая	/ Ограничение горячей воды отрегулировано неправильно	/ Отрегулируйте ограничение горячей воды



△ TURVALLISUUSOHJEET

- △ Asennuksessa on käytettävä käsineitä puristumien ja viiltojen aiheuttamien tapaturmien estämiseksi.
- △ Suuret paine-erot kylmä- ja kuumavesiliitäntöjen välillä on tasattava.

ASENNUSOHJEET

- / Ennen asennusta on tarkastettava tuotteen mahdolliset kuljetusvahingot. Asennuksen jälkeen kuljetus- ja pintavaurioita ei hyväksytä.
- / Putket ja hana on asennettava, huuhdeltava ja tarkastettava voimassa olevien standardien mukaisesti.
- / Jokaisessa maassa on noudatettava siellä päteviä asennusohjeita.
- / 12803000: Armaturia ei voi käyttää läpimenoveden-kuumentimen yhteydessä.

TEKNISET TIEDOT

Käyttöpaine:	maks. 1 MPa
Suosittelua käyttöpaine:	0,1 - 0,5 MPa
Koestuspaine:	1,6 MPa (1 MPa = 10 bar = 147 PSI)
Kuuman veden lämpötila:	maks. 70°C
Kuuman veden suosituslämpötila:	65°C
Lämpödesinfektio:	maks. 70°C/4 min

Tuote on suunniteltu käytettäväksi ainoastaan juomaveden kanssa!

MERKIN KUVAUS



Älä käytä etikkahappopitoista silikonial



MITAT (katso sivu 35)



VIRTAUSDIAGRAMMI
(katso sivu 36)



PUHDISTUS (katso sivu 38)



HUOLTO (katso sivu 39)

Vastaventtiilien toiminta on tarkastettava säännöllisesti paikallisten ja kansallisten määräysten mukaisesti (DIN EN 1717, vähintään kerran vuodessa).



VARAOSAT (katso sivu 40)

ERITYISVARUSTE (ei kuulu toimitukseen)



/ suihkusäädin #97474000 (katso sivu 32)



/ Sovitin (G $\frac{1}{2}$ /G $\frac{3}{4}$) #93395000
(katso sivu 41)



KÄYTTÖ (katso sivu 37)

Hansgrohe suosittelee, että ensimmäistä puolta litraa ei käytetä juomavedenä aamuisin eikä silloin, kun laitetta ei ole käytetty pitkään aikaan.



KOESTUSMERKKI (katso sivu 42)

HÄIRIÖ

SYY

TOIMENPIDE

/ Hana on raskaskäyttöinen	/ Patruuna rikki, kalkkikerrostumia	/ Vaihda patruuna
/ Hanasta tippuu vettä	/ Patruuna rikki	/ Vaihda patruuna
/ Vettä valuu kiinnityskauluksesta	/ Liitosletkut eivät ole kierretty kiinni perusrunkoon pohjaan asti	/ Kierrä liitosletkut kiinni käsikireyteen
	/ Liitosletkun O-renkas on rikki	/ Vaihda O-renkas
/ Lämminveden lämpötila liian alhainen	/ Lämminveden rajoitin väärin säädetty	/ Sääädä lämminveden rajoitin



⚠ SÄKERHETSANVISNINGAR

- ⚠ Handskar ska bäras under monteringsarbetet så att man kan undvika kläm- och skärskador.
- ⚠ Stora tryckskillnader mellan anslutningarna för varmt och kallt vatten måste utjämnas.

MONTERINGSANVISNINGAR

- / Det måste undersökas om produkten har transportskador innan den monteras. Efter monteringen accepteras inga transport- eller ytskiktskador.
- / Ledningarna och blandaren måste monteras, spolats igenom och kontrolleras enligt de gällande normerna.
- / De installationsriktlinjer som gäller i länderna ska följas.
- / 12803000: Blandaren kan inte användas tillsammans med en varmvattenberedare.

TEKNISKA DATA

Driftstryck:	max. 1 MPa
Rek. driftstryck:	0,1 - 0,5 MPa
Tryck vid provtryckning:	1,6 MPa
	(1 MPa = 10 bar = 147 PSI)
Varmvattentemperatur:	max. 70°C
Rek. varmvattentemp.:	65°C
Termisk desinfektion:	max. 70°C / 4 min
Produkten är enbart avsedd för dricksvatten!	

SYMBOLFÖRKLARING



Använd inte silikon som innehåller ättiksyra!



MÅTTEN (se sidan 35)



FLÖDESSCHEMA (se sidan 36)



RENGÖRING (se sidan 38)



SKÖTSEL (se sidan 39)

Backventilers funktion måste kontrolleras regelbundet enligt nationella eller regionala bestämmelser i enlighet med DIN EN 1717 (minst en gång per år).



RESERVDELAR (se sidan 40)

SPECIALTILLBEHÖR
(medföljer ej leveransen)



/ Utjämningsset #97474000 (se sidan 32)



/ Adapter (G $\frac{1}{2}$ / G $\frac{3}{4}$) #93395000
(se sidan 41)



HANTERING (se sidan 37)

Hansgrohe rekommenderar att den första halvlitern inte används som dricksvatten på morgonen eller efter längre perioder utan användning.



TESTSIGILL (se sidan 42)

STÖRNING

ORSAK

ÅTGÄRD

/ Blandare är trög	/ Patron defekt, förkalkad	/ Byt ut patron
/ Blandare droppar	/ Patron defekt	/ Byt ut patron
/ Vatten kommer ut vid monteringsstaget	/ Anslutnings slangar inte helt inskruvade i grundkonstruktionen	/ Drag fast anslutnings slangar för hand.
	/ O-ring på anslutnings slang defekt	/ Byt ut O-ring
/ Varmvattentemperaturen är för låg	/ Varmvattenreglering felaktigt inställd	/ Ställ in varmvattenreglering



△ SAUGUMO TECHNIKOS NURODYMAI

- △ Apsaugai nuo užspaudimo ir įsijovimo montavimo metu mūvėkite pirštines.
- △ Turi būti išlyginti šalto ir karšto slėgio nelygumai.

MONTAVIMO INSTRUKCIJA

- / Prieš montuojant būtina patikrinti, ar gaminys nebuvo pažeistas transportavimo metu. Sumontavus pretenzijos dėl transportavimo ir paviršiaus pažeidimų nepriimamos.
- / Vamzdžiai ir sujungimai turi būti montuojami, plaunami ir tikrinami pagal galiojančias normas.
- / Laikykitės atitinkamoje šalyje galiojančių direktyvų dėl įrengimo.
- / 12803000: Armatūros negalima naudoti kartu su tekančio vandens šildytuvu.

TECHNINIAI DUOMENYS

Darbinis slėgis: ne daugiau kaip 1 MPa
 Rekomenduojamas slėgis: 0,1 - 0,5 MPa
 Bandomasis slėgis: 1,6 MPa

(1 MPa = 10 barų = 147 PSI)

Karšto vandens temperatūra: ne daugiau kaip 70°C
 Rekomenduojama karšto vandens temperatūra: 65°C
 Terminis dezinfekavimas: ne daugiau kaip 70°C / 4 min
 Produktas skirtas tik geriamajam vandeniui!

SIMBOLIO APRAŠYMAS



Nenaudokite silikono, kurio sudėtyje yra acto rūgšties!



IŠMATAVIMAI (žr. psl. 35)



PRALAUDIMO DIAGRAMA (žr. psl. 36)



VALYMAS (žr. psl. 38)



TECHNINIS APTARNAVIMAS (žr. psl. 39)

Atbulinio vožtuvo apsauga privalo būti tikrinama reguliariai (mažiausiai kartą per metus) pagal DIN EN1717 arba pagal galiojančias nacionalines arba regionines normas.



ATSARGINĖS DALYS (žr. psl. 40)

SPECIALŪS PRIEDAI (nėra pridedama)



/ lygio reguliatorius #97474000 (žr. psl. 32)



/ Adapteris (G1/2 / G3/4) #93395000 (žr. psl. 41)



EKSPLOATACIJA (žr. psl. 37)

Naudojant po ilgesnės pertraukos, „Hansgrohe“ rekomenduoją pirmo pusės litro vandens nevertoti kaip geriamojo.



BANDYMO PAŽYMA (žr. psl. 42)

GEDIMAS

- / Sunkiai sukiojama rankenėlė
- / Maišytuvus praleidžia vandenį
- / Prateka vanduo per tvirtinimo kotą
- / Per maža karšto vandens temperatūra

PRIEŽASTIS

- / Kasetė pažeista, užkalkėjusi
- / Kasetė pažeista
- / Prijungimo žarnos nepilnai įsuktos į korpusą
- / Pajungimo žarnos tarpinė pažeista
- / Neteisingai nustatytas karšto vandens ribotuvus

PRIEMONĖ

- / Pakeisti kasetę
- / Pakeisti kasetę
- / Prijungimo žarnas prisukti ranka
- / tarpinę pakeisti
- / Nustatyti karšto vandens ribotuvą



⚠ SIGURNOSNE UPUTE

- ⚠ Prilikom montaže se radi sprječavanja prignječenja i posjekotina moraju nositi rukavice.
- ⚠ Velika razlika u pritisku između vruće i hladne vode mora biti izbalansirana.

UPUTE ZA MONTAŽU

- / Prije montaže mora se provjeriti je li proizvod oštećen prilikom transporta. Nakon ugradnje se ne priznaju nikakve reklamacije koje se odnose na površinska i transportna oštećenja.
- / Cijevi i armatura moraju biti postavljeni, isprani i testirani prema važećim normama.
- / Obvezno se moraju uvažiti propisi o instalacijama koji vrijede u dotičnoj zemlji.
- / 12803000: Armatura se ne može rabiti u kombinaciji sa protočnim bojlerom.

TEHNIČKI PODATCI

Najveći dopušteni tlak:	tlak 1 MPa
Preporučeni tlak:	0,1 - 0,5 MPa
Probni tlak:	1,6 MPa
	(1 MPa = 10 bar = 147 PSI)
Temperatura vruće vode:	tlak 70°C
Preporučena temperatura vruće vode:	65°C
Termička dezinfekcija:	tlak 70°C / 4 min
Proizvod je koncipiran isključivo za pitku vodu!	

OPIS SIMBOLA



Nemojte koristiti silikon koji sadrži octenu kiselinu!



MJERE (pogledaj stranicu 35)



DIJAGRAM PROTOKA (pogledaj stranicu 36)



ČIŠĆENJE (pogledaj stranicu 38)



ODRŽAVANJE (pogledaj stranicu 39)

Ispravnost nepovratnog ventila mora se redovito provjeravati prema standardu DIN EN 1717 i u skladu sa važećim propisima (najmanje jednom godišnje).



REZERVNI DJELOVI (pogledaj stranicu 40)

POSEBNI PRIBOR (Nije sadržano u isporucil)



/ komplet za podešavanje #97474000 (pogledaj stranicu 32)



/ Prilagodnik (G $\frac{1}{2}$ /G $\frac{3}{4}$) #93395000 (pogledaj stranicu 41)



UPOTREBA (pogledaj stranicu 37)

Hansgrohe preporuča da ujutro ili nakon duljeg nekorištenja prvih 1/2 litre vode ne upotrebljavate za piće.



OZNAKA TESTIRANJA (pogledaj stranicu 42)

GREŠKA

- / Ručica se zaglavila
- / Slavina kaplje
- / Voda izlazi na dijelu gdje je slavina učvršćena
- / Preniska temperatura tople vode

UZROK

- / Neispravan uložak Taloženje kamenca
- / Neispravan uložak
- / Priključna crijeva nisu potpuno učvršćena na tijelo
- / O-prsteni priključnih crijeva su neispravni
- / Limiter vruće vode nije dobro podešen

OTKLANJANJE

- / Zamijenite uložak
- / Zamijenite uložak
- / Priključna crijeva učvrstite rukom
- / Zamijenite O-prsten
- / Podesite limiter vruće vode



△ GÜVENLİK UYARILARI

- △ Montaj esnasında ezilme ve kesilme gibi yaralanmaları önlemek için eldiven kullanılmalıdır.
- △ Sıcak ve soğuk su bağlantıları arasında büyük basınç farklılıkları varsa, bu basınç farklılıklarının dengelenmesi gerekir.

MONTAJ AÇIKLAMALARI













- / Montaj işleminden önce ürün nakliye hasarları yönünden kontrol edilmelidir. Montaj işleminden sonra nakliye veya yüzey hasarları için sorumluluk üstlenilmektedir.
- / Boruların ve armatürün montajı, yıkanması ve kontrolü geçerli normlara göre yapılmalıdır.
- / Ülkelerde geçerli kurulum yönetmeliklerine riayet edilmelidir.
- / 12803000: Armatür bir akış ısıtıcısı ile birlikte kullanılamaz.

TEKNİK BİLGİLER

İşletme basıncı:	azami 1 MPa
Tavsiye edilen işletme basıncı:	0,1 - 0,5 MPa
Kontrol basıncı:	1,6 MPa
	(1 MPa = 10 bar = 147 PSI)
Sıcak su sıcaklığı:	azami 70°C
Tavsiye edilen su ısısı:	65°C
Termik dezenfeksiyon:	azami 70°C/4 dak

Ürün sadece şebeke suyu için tasarlanmıştır!

SİMGE AÇIKLAMASI

-  Asetik asit içeren silikon kullanmayın!
-  ÖLÇÜLERİ (bakınız sayfa 35)
-  AKIŞ DİYAGRAMI (bakınız sayfa 36)
-  TEMİZLEME (bakınız sayfa 38)
-  BAKIM (bakınız sayfa 39)
-  DIN EN 1717 ve ulusal standartlar doğrultusunda Çek valfler düzenli olarak kontrol edilmelidir. (en az yılda bir kez)
-  YEDEK PARÇALAR (bakınız sayfa 40)
-  ÖZEL AKSESUARLAR (Teslimat kapsamına dahil değildir)
-  / tesfiye ayarlı #97474000 (bakınız sayfa 32)
-  / Adaptör (G½/G¾) #93395000 (bakınız sayfa 41)
-  KULLANIMI (bakınız sayfa 37)
-  Hansgrohe sabahları uzun durgunluk süresi sonrasında ilk yarım litre suyun içme suyu olarak kullanılmamasını önerir.
-  KONTROL İŞARETİ (bakınız sayfa 42)

ARIZA	SEBEP	YARDIM
/ Batarya kullanımı ağırlaşıyor	/ Kartuş Bozulmuş ve kireçlenmiş olabilir	/ Kartuşu değiştirin
/ Batarya su damlatıyor	/ Kartuş bozuk olabilir	/ Kartuşu değiştirin
/ Sabitleme kutusundan su çıkışı	/ Bağlantı hortumları ana gövdeye tamamen vidalanmamış	/ Bağlantı hortumlarını elinizle sıkın
	/ Bağlantı hortumundaki O-ring arızalı	/ O-ringi değiştirin
/ Sıcak suyun derecesi çok düşük	/ Isı limitleyici düzgün çalışmıyor	/ Isı limitleyiciyi yeniden ayarlayın



⚠️ INSTRUCȚIUNI DE SIGURANȚĂ

- ⚠️ La montare utilizați mănuși pentru evitarea contuziunilor și tăierii mâinilor.
- ⚠️ Diferențele de presiune mari între alimentarea cu apă rece și apă caldă trebuie echilibrate.









INSTRUCȚIUNI DE MONTARE

- / Înainte de instalare verificați, dacă produsul prezintă deteriorări de transport. După instalare garanția nu acoperă deteriorările de transport și cele de suprafață.
- / Conductele și bateriile trebuie montate, spălate și verificate conform normelor în vigoare.
- / Respectați reglementările referitoare la instalare valabile în țara respectivă.
- / 12803000: Bateria nu poate fi utilizată în combinație cu un boiler în flux continuu.

DATE TEHNICE

- Presiune de funcționare: max. 1 MPa
 Presiune de funcționare recomandată: 0,1 - 0,5 MPa
 Presiune de verificare: 1,6 MPa
 (1 MPa = 10 bar = 147 PSI)
- Temperatura apei calde: max. 70°C
 Temperatura recomandată a apei calde: 65°C
 Dezinfecție termică: max. 70°C/4 min
- Produsul este destinat exclusiv pentru apă potabilă.

DESCRIEREA SIMBOLURILOR

-  Nu utilizați silicon cu conținut de acid acetic!
-  DIMENSIUNI (vezi pag. 35)
-  DIAGRAMA DE DEBIT (vezi pag. 36)
-  CURĂȚARE (vezi pag. 38)
-  ÎNTREȚINERE (vezi pag. 39)
- Supapele antiretur trebuie verificate regulat conform DIN EN 1717 și standardele naționale sau regionale (cel puțin o dată pe an).
-  PIESE DE SCHIMB (vezi pag. 40)
- ACCESORII OPȚIONALE (nu este inclus în setul livrat)
-  / Set sortimente #97474000 (vezi pag. 32)
-  / Adaptor (G½/G¾) #93395000 (vezi pag. 41)
-  UTILIZARE (vezi pag. 37)
- Hansgrohe vă recomandă, ca dimineața sau după perioade mai lungi de pauză să nu folosiți prima jumătate de litru de apă pentru băut.
-  CERTIFICAT DE TESTARE (vezi pag. 42)

DERANJAMENT	CAUZA	MĂSURI DE REMEDIERE
/ Bateria se mișcă dificil	/ Cartuș defect din cauza depunerilor de calcar	/ Schimbați cartușul.
/ Bateria picură	/ Cartuș defect	/ Schimbați cartușul.
/ Scurgere de apă la șaftul de fixare.	/ Furtunurile de racordare nu sunt bine înșurubate în corpul bateriei.	/ Strângeți cu mâna furtunurile de racordare.
	/ Inelul O de la furtunul de racord defect	/ Schimbați inelul O.
/ Temperatura apei calde este prea mică	/ Limitarea temperaturii apei calde setată incorect.	/ Setați limitarea temperaturii apei calde.



ΔΥΠΟΔΕΙΞΕΙΣ ΑΣΦΑΛΕΙΑΣ

- Δ Για να αποφύγετε τραυματισμούς κατά τη συναρμολόγηση πρέπει να φοράτε γάντια.
- Δ Οι διαφορές της πίεσης μεταξύ της σύνδεσης κρύου και ζεστού νερού θα πρέπει να αντισταθμίζονται.

ΟΔΗΓΙΕΣ ΣΥΝΑΡΜΟΛΟΓΗΣΗΣ

- / Πριν τη συναρμολόγηση πρέπει να εξεταστεί το προϊόν για ζημιές μεταφοράς. Μετά την εγκατάσταση δεν αναγνωρίζονται ζημιές από τη μεταφορά ή επιφανειακές ζημιές.
- / Οι σωλήνες και η μπαταρία πρέπει να τοποθετηθούν σύμφωνα με τα ισχύοντα πρότυπα, να τεθούν υπό πίεση και να δοκιμαστούν.
- / Θα πρέπει να τηρούνται οι οδηγίες εγκατάστασης που ισχύουν σε κάθε κράτος.
- / 12803000: Η μπαταρία δεν μπορεί να χρησιμοποιηθεί σε συνδυασμό με ταχυθερμοσίφωνα.

ΤΕΧΝΙΚΑ ΧΑΡΑΚΤΗΡΙΣΤΙΚΑ

- Λειτουργία πίεσης: έως 1 MPa
 Συνιστώμενη λειτουργία πίεσης: 0,1 - 0,5 MPa
 Πίεση ελέγχου: 1,6 MPa
 (1 MPa = 10 bar = 147 PSI)
- Θερμοκρασία ζεστού νερού: έως 70°C
 Συνιστώμενη θερμοκρασία ζεστού νερού: 65°C
 Θερμική απολύμανση: έως 70°C / 4 min
- Το προϊόν έχει σχεδιαστεί αποκλειστικά για πόσιμο νερό!

ΠΕΡΙΓΡΑΦΗ ΣΥΜΒΟΛΩΝ



Μην χρησιμοποιείτε σιλικόνη που περιέχει οξικό οξύ!



ΔΙΑΣΤΑΣΕΙΣ (βλ. Σελίδα 35)



ΔΙΑΓΡΑΜΜΑ ΡΟΗΣ (βλ. Σελίδα 36)



ΚΑΘΑΡΙΣΜΟΣ (βλ. Σελίδα 38)

ΣΥΝΤΗΡΗΣΗ (βλ. Σελίδα 39)

Οι βαλβίδες αντεπιστροφής πρέπει να ελέγχονται τακτικά ως προς τη λειτουργία τους, σύμφωνα με το πρότυπο DIN EN 1717, σε σχέση με τους ισχύοντες εθνικούς ή τοπικούς κανόνες (το ελάχιστο μια φορά το χρόνο).



ΑΝΤΑΛΛΑΚΤΙΚΑ (βλ. Σελίδα 40)

ΕΙΔΙΚΑ ΑΞΕΣΟΥΡΑ (δεν περιλαμβάνεται στον παραδοτέο εξοπλισμό)



/ σετ οριζοντίωσης (αλφάδιασμα) #97474000 (βλ. Σελίδα 32)



/ Προσαρμογέας (G¹/₂ / G³/₄) #93395000 (βλ. Σελίδα 41)



ΧΕΙΡΙΣΜΟΣ (βλ. Σελίδα 37)

Η Hansgrohe συνιστά το πρώι ή μετά από μεγάλα χρονικά διαστήματα αχρησίας να μην χρησιμοποιείτε το πρώτο μισό λίτρο νερό σαν πόσιμο.



ΣΗΜΑ ΕΛΕΓΧΟΥ (βλ. Σελίδα 42)

ΒΛΑΒΗ

ΑΙΤΙΑ

ΔΙΨΡΘΩΣΗ

/ Σκληρή μπαταρία (μείκτης)	/ Ελαττωματικό φυσιγίο, άλατα	/ Αλλαγή φυσιγγίου
/ Η μπαταρία στάζει	/ Ελαττωματικό φυσιγίο	/ Αλλαγή φυσιγγίου
/ Διαρροή νερού στον άξονα στερέωσης	/ Οι σωλήνες σύνδεσης δεν είναι πλήρως βιδωμένοι στο βασικό κορμό	/ Σφίξτε τους σωλήνες σύνδεσης με το χέρι
	/ Ο στρογγυλός δακτύλιος στο σωλήνα σύνδεσης είναι ελαττωματικός	/ Αλλάξτε το στρογγυλό δακτύλιο
/ Χαμηλή θερμοκρασία ζεστού νερού	/ Λάθος ρύθμιση της περιοριστικής διάταξης ζεστού νερού	/ Ρυθμίστε την περιοριστική διάταξη του ζεστού νερού



△ VARNOSTNA OPOZORILA

- △ Pri montaži je treba nositi rokavice, da se preprečijo poškodbe zaradi zmečkanja ali urezov.
- △ Velike razlike v tlaku med priključkom za mrzlo in priključkom za toplo vodo je potrebno izravnati.

NAVODILA ZA MONTAŽO

- / Pred montažo je treba izdelek preveriti glede morebitnih transportnih poškodb. Po vgradnji transportne ali površinske poškodbe ne bodo več priznane.
- / Cevi in armaturo je treba montirati, izprati in preveriti po veljavnih standardih.
- / Upoštevati je treba pravilnike o inštalacijah, ki veljajo v posamezni državi.
- / 12803000: Armature ni možno uporabiti v povezavi s pretočnim grelnikom.

TEHNIČNI PODATKI

Delovni tlak:	maks. 1 MPa
Priporočeni delovni tlak:	0,1 - 0,5 MPa
Preskusni tlak:	1,6 MPa (1 MPa = 10 bar = 147 PSI)
Temperatura tople vode:	maks. 70°C
Priporočena temperatura tople vode:	65°C
Termična dezinfekcija:	maks. 70°C / 4 min

Proizvod je zasnovan izključno za sanitarno vodo!

OPIS SIMBOLA



Ne smete uporabiti silikona, ki vsebuje ocatno kislino!



MERE (glejte stran 35)



DIAGRAM PRETOKA
(glejte stran 36)



ČIŠČENJE (glejte stran 38)



VZDRŽEVANJE (glejte stran 39)

Delovanje protipovratnega ventila je potrebno v skladu z DIN EN 1717 in skladno z državnimi in regionalnimi določili redno testirati (najmanj enkrat letno).



REZERVNI DELI (glejte stran 40)

POSEBEN PRIBOR (Ni vključeno)



/ Izravnalni komplet #97474000
(glejte stran 32)



/ Adapter (G $\frac{1}{2}$ /G $\frac{3}{4}$) #93395000
(glejte stran 41)



UPRAVLJANJE (glejte stran 37)

Hansgrohe priporoča, da zjutraj ali po daljšem času stagnacije prvega pol litra vode ne uporabite kot pitno vodo.



PRESKUSNI ZNAK (glejte stran 42)

NAPAKA	VZROK	POMOČ
/ Teško premikanje armature	/ Pokvarjen vložek, poapneno	/ Zamenjajte vložek
/ Iz armature kaplja	/ Pokvarjen vložek	/ Zamenjajte vložek
/ Uhajanje vode ob pritrdilnem nastavku	/ Priključne cevi niso popolnoma privijene v osnovno ogrodje	/ Ročno zatisnite priključne cevi
	/ Obročna tesnila priključnih gibkih cevi so pokvarjena	/ Zamenjajte obročno tesnilo
/ Prenizka temperatura tople vode	/ Omejevalnik tople vode ni pravilno nastavljen	/ Nastavite omejevalnik tople vode

△ OHUTUSJUHISED

- △ Kandke paigaldamisel muljumis- ja löikevigastuste vältimiseks kindaid.
- △ Kui külma ja kuumu vee ühenduste surve on väga erinev, tuleb need tasakaalustada.

PAIGALDAMISJUHISED











- / Enne paigaldamist tuleb toodet kontrollida transpordikahjustuste osas. Pärast paigaldamist ei tunnustata enam transpordi- või pinnakahjustuste kaebuseid.
- / Voolikute ja segisti paigaldamisel, loputamisel ja kontrollimisel tuleb lähtuda kehtivatest normatiividest.
- / Vastavas riigis kehtivaid paigalduseeskirju tuleb järgida.
- / 12803000: Segistit ei saa kasutada koos läbivooluveesoojendiga.

TEHNILISED ANDMED

Töörõhk	maks. 1 MPa
Soovitatav töörõhk:	0,1 - 0,5 MPa
Kontrollsurve:	1,6 MPa (1 MPa = 10 baari = 147 PSI)
Kuumu vee temperatuur:	maks. 70°C
Soovitatav kuumu vee temperatuur:	65°C
Terminline desinfitatsioon:	maks. 70°C/4 min

Toode on ette nähtud eranditult joogivee jaoks!

SÜMBOLITE KIRJELDUS

-  Ärge kasutage äädikhapet sisaldavat silikoonil
-  MÕÕTUDE (vt lk 35)
-  LÄBIVOOLUDIAGRAMM (vt lk 36)
-  PUHASTAMINE (vt lk 38)
-  HOOLDUS (vt lk 39)
- Tagasilöögiklappide toimimist tuleb kooskõlas riiklike ja regionaalsete määrustega regulaarselt kontrollida vastavalt standardile DIN EN 1717 (vähemalt kord aastas).
-  VARUOSAD (vt lk 40)
- SPETSIAALNE LISAVARUSTUS (ei sisaldu komplektis)
-  / tasanduskomplekt #97474000 (vt lk 32)
-  / Adapter (G½/G¾) #93395000 (vt lk 41)
-  KASUTAMINE (vt lk 37)
- Hansgrohe soovib mitte kasutada esimest poolt liitrit hommikuti või pärast pikemat seisakuaega joogiveena.
-  KONTROLLSERTIFIKAAT (vt lk 42)

RIKE	PÕHJUS	LAHENDUS
/ Segisti käib raskelt	/ Tööelement on katkine, lubjastunud	/ Vahetage tööelement
/ Segisti tilgub	/ Tööelement on katkine	/ Vahetage tööelement
/ Veeleke kinnituse juures	/ Ühendusvoolikud ei ole korralikult põhi- korpuse külge kruvitud	/ Kruvige ühendusvoolikud käega kinni
	/ Ühendusvoolikute O-rõngastihendid katki	/ Vahetage O-rõngastihend
/ Sooja vee temperatuur liiga madal	/ Kuumu vee piirang valesti seatud	/ Seadke kuumu vee piirang



△ DROŠĪBAS NORĀDES

- △ Montāžas laikā, lai izvairītos no saspiedumiem un iegrīzumiem, nepieciešams nēsāt cimdus.
- △ Jāizlīdzina spiediena atšķirības starp aukstā un karstā ūdens pievadiem.

NORĀDĪJUMI MONTĀŽAI

- / Pirms montāžas nepieciešams pārbaudīt, vai produktam transportēšanas laikā nav radušies bojājumi. Pēc iebūvēšanas bojājumi, kas radušies transportēšanas laikā, vai virsmas bojājumi netiek atzīti.
- / Caurulvadi un armatūra ir jāuzstāda, jāizskalo un jāpārbauda saskaņā ar spēkā esošajiem standartiem.
- / Jāievēro attiecīgās valstīs spēkā esošās montāžas prasības.
- / 12803000: Armatūru nevar izmantot kopā ar caurplūdes sildītāju.

TEHNISKIE DATI











Darba spiediens: maks. 1 MPa
 Ieteicamais darba spiediens: 0,1 - 0,5 MPa
 Pārbaudes spiediens: 1,6 MPa

(1 MPa = 10 bar = 147 PSI)

Karstā ūdens temperatūra: maks. 70°C
 Ieteicamā karstā ūdens temperatūra: 65°C
 Termiskā dezinfekcija: maks. 70°C / 4 min

Izstrādājums ir paredzēts tikai dzeramajam ūdenim!

SIMBOLU NOZĪME

-  Neizmantojiet silikonu, kas satur etiķskābi!
-  IZMĒRUS (skat. lpp. 35)
-  CAURPLŪDES DIAGRAMMA (skat. lpp. 36)
-  TĪRĪŠANA (skat. lpp. 38)
-  APKOPE (skat. lpp. 39)
- Regulāri jāpārbauda pretvārsta funkcija saskaņā ar DIN EN 1717 saistībā ar nacionālajiem vai vietējiem noteikumiem (vismaz vienreiz gadā).
-  REZERVES DAĻAS (skat. lpp. 40)
- SPECIĀLI AKSESUĀRI (komplektā netiek piegādāts)
-  / nolīdzināšanas komplekts #97474000 (skat. lpp. 32)
-  / Adapteris (G $\frac{1}{2}$ /G $\frac{3}{4}$) #93395000 (skat. lpp. 41)
-  LIETOŠANA (skat. lpp. 37)
- Hänsgrohe iesaka no rīta vai pēc ilgākiem pārtraukumiem nelietot pirmo puslitru ūdens dzeršanai.
-  PĀRBAUDES ZĪME (skat. lpp. 42)

TRAUCĒJUMS

IEMESLS

BOJĀJUMU NOVĒRŠANA

/ Jaucējkrāns smagi grozāms	/ Bojāta kartuša, aizkaļķojusies	/ Nomainīt kartušu
/ Jaucējkrāns pil	/ Bojāta kartuša	/ Nomainīt kartušu
/ Ūdens noplūde pie nostiprinājuma	/ Pieslēguma šļūtenes nav līdz galam ieskrūvētas pamatelementā	/ Pieslēguma šļūtenes ar roku pievilkt stingrāk
	/ Bojāti pieslēguma šļūtenju O-gredzeni	/ Nomainīt O-gredzenu
/ Pārāk zema ūdens temperatūra	/ Nepareizi noregulāta karstā ūdens bloķēšana	/ Noregulēt karstā ūdens ierobežošanu



△ SIGURNOSNE NAPOMENE

- △ Prilikom montaže se radi sprečavanja prignječenja i posekotina moraju nositi rukavice.
- △ Velika razlika u pritisku između vruće i hladne vode mora biti izbalansirana.







INSTRUKCIJE ZA MONTAŽU

- / Pre montaže se mora proveriti da li je proizvod oštećen pri transportu. Nakon ugradnje se ne priznaju nikakve reklamacije koje se odnose na površinska i transportna oštećenja.
- / Vodovi i armatura moraju biti postavljeni, isprani i testirani prema važećim normama.
- / Treba se pridržavati propisa koji u određenim zemljama važe za instalacije.
- / 12803000: Armatura se ne može upotrebljavati u kombinaciji sa protočnim bojlerom.

TEHNIČKI PODACI

Radni pritisak:	maks. 1 MPa
Preporučeni radni pritisak:	0,1 - 0,5 MPa
Probni pritisak:	1,6 MPa
	(1 MPa = 10 bar = 147 PSI)
Temperatura vruće vode:	maks. 70°C
Preporučena temperatura vruće vode:	65°C
Termička dezinfekcija:	maks. 70°C / 4 min
Proizvod je koncipiran isključivo za pijaću vodu!	

OPIS SIMBOLA

-  Nemojte koristiti silikon koji sadrži sircetnu kiselinu!
-  MERE (vidi stranu 35)
-  DIJAGRAM PROTOKA (vidi stranu 36)
-  ČIŠĆENJE (vidi stranu 38)
-  ODRŽAVANJE (vidi stranu 39)
- Ispravno funkcionisanje nepovratnog ventila se mora redovno proveravati prema standardu DIN EN 1717 i u skladu s važećim nacionalnim ili regionalnim propisima (najmanje jednom godišnje).
-  REZERVNI DELOVI (vidi stranu 40)
- POSEBAN PRIBOR (Nije sadržano u isporuci)
-  / set za nivelisanje #97474000 (vidi stranu 32)
-  / Adapter (G $\frac{1}{2}$ / G $\frac{3}{4}$) #93395000 (vidi stranu 41)
-  RUKOVANJE (vidi stranu 37)
- Hansgrohe preporučuje da ujutru ili nakon dužeg nekorisćenja prvih pola litre vode ne koristite za piće.
-  ISPITNI ZNAK (vidi stranu 42)

SMETNJA	UZROK	POMOĆ
/ Ručica se zaglavila	/ Neispravna kartuša, nataloženi kamenac	/ Zamenite kartušu
/ Slavina kaplje	/ Neispravna kartuša	/ Zamenite kartušu
/ Voda izlazi na delu gde je slavina učvršćena	/ Priključna creva nisu potpuno učvršćena na telo	/ Priključna creva učvrstite rukom
	/ O prstenovi priključnih creva su neispravni	/ Zamenite O prsten
/ Preniska temperatura tople vode	/ Ograničavač vruće vode nije dobro podešen	/ Podesite ograničavač vruće vode

△ SIKKERHETSHENVISNINGER

- △ Bruk hansker under montasjen for å unngå klem- og kuttskader.
- △ Store trykkdifferanser mellom kaldt- og varmtvannstilkoblinger skal utlignes.

MONTAGEHENVISNINGER

- / Før montasjen skal produktet sjekkes for transportskader. Etter monteringen aksepteres ikke noen transport- eller overflateskader.
- / Ledningene og armaturen skal monteres, spyles og sjekkes iht. de gjeldende normer.
- / Gjeldende retningslinjer for rørleggerarbeid i de enkelte land skal følges.
- / 12803000: Armaturen kan ikke brukes i forbindelse med en gjennomstrømningsvannvarmer.

TEKNISKE DATA

Driftstrykk	maks. 1 MPa
Anbefalt driftstrykk:	0,1 - 0,5 MPa
Prøvetrykk	1,6 MPa
	(1 MPa = 10 bar = 147 PSI)
Varmtvannstemperatur	maks. 70°C
Anbefalt temperatur for varmt vann	65°C
Termisk desinfisering:	maks. 70°C/4 min
Produktet er utelukkende designet for drikkevann!	

SYMBOLBESKRIVELSE



Ikke bruk silikon som inneholder eddiksyre!



MÅL (se side 35)



GJENNOMSTRØMNINGSDIAGRAM (se side 36)



RENGJØRING (se side 38)



VEDLIKEHOLD (se side 39)

Funksjonen til returløpssperren skal iht. DIN EN 1717 og i samsvar med de nasjonale og lokale forskrifter sjekkes regelmessig (minst en gang i året).



SERVICEDELER (se side 40)

EKSTRATILBEHØR

(ikke med i leveransen)



/ Utligningssett #97474000 (se side 32)



/ Adapter (G $\frac{1}{2}$ /G $\frac{3}{4}$) #93395000 (se side 41)



BETJENING (se side 37)

Om morgen og etter lengre stagnasjonstider anbefaler Hansgrohe å ikke bruke den første halvliteren som drikkevann.



PRØVEMERKE (se side 42)

FEIL	ÅRSAK	FEILRETTELSE
/ Armatur ikke lett bevegelig	/ Kartusj defekt, forkalkning	/ Kartusj byttes
/ Armatur drypper	/ Kartusj defekt	/ Kartusj byttes
/ Vannlekkasje på festeskift	/ Tilkoblingsslanger ikke skrudd helt inn i bauselement	/ Tilkoblingsslanger trekkes fast fra hånd
	/ O-ring på tilkoblingsslangen defekt	/ O-ring byttes
/ For lav varmtvannstemperatur	/ Varmtvannsbegrensning er feil innstilt	/ Varmtvannsbegrensning innstilles



⚠ УКАЗАНИЯ ЗА БЕЗОПАСНОСТ

- ⚠ При монтажа трябва да се носят ръкавици, за да се избегнат наранявания поради притискане или порязване.
- ⚠ Големите разлики в налягането между изводите за студената и топлата вода трябва да се изравняват.











УКАЗАНИЯ ЗА МОНТАЖ

- / Преди монтажа продуктът трябва да се провери за транспортни щети. След монтажа не се признават транспортни или повърхностни щети.
- / Тръбопроводите и арматурата трябва да се монтират, промият и проверят в съответствие с валидните норми.
- / Трябва да бъдат спазвани валидните в съответните страни предписания за инсталиране.
- / 12803000: Арматурата не може да се използва във връзка с проточен нагревател.

ТЕХНИЧЕСКИ ДАННИ

Работно налягане:	макс. 1 МПа
Препоръчително работно налягане:	0,1 - 0,5 МПа
Контролно налягане:	1,6 МПа
	(1 МПа = 10 bar = 147 PSI)
Температура на горещата вода:	макс. 70°C
Препоръчителна температура на горещата вода:	65°C
Термична дезинфекция:	макс. 70°C / 4 мин
Продуктът е разработен само за питейна вода!	

ОПИСАНИЕ НА СИМВОЛИТЕ

-  Не използвайте силикон, съдържащ оцетна киселина!
-  РАЗМЕРИ (вижте стр. 35)
-  ДИАГРАМА НА ПОТОКА (вижте стр. 36)
-  ПОЧИСТВАНЕ (вижте стр. 38)
-  ПОДДРЪЖКА (вижте стр. 39)
- Съгласно DIN EN 1717 функционирането на приспособленията за предотвратяване на обратния поток трябва редовно да се проверява в съответствие с националните или регионални изисквания (поне веднъж годишно).
-  СЕРВИЗНИ ЧАСТИ (вижте стр. 40)
- СПЕЦИАЛНИ ПРИНАДЛЕЖНОСТИ (не се съдържа в обема на доставка)
 -  / изравняваща система #97474000 (вижте стр. 32)
 -  / Адаптер (G¹/₂ / G³/₄) #93395000 (вижте стр. 41)
 -  ОБСЛУЖВАНЕ (вижте стр. 37)
- Hansgrohe препоръчва, сутрин и след по-продължително спиране първият половин литър да не се използва като питейна вода.
-  КОНТРОЛЕН ЗНАК (вижте стр. 42)

НЕИЗПРАВНОСТ

ПРИЧИНА

ПОМОЩ

/ Трудно подвижна арматура	/ Дефектна гилза, покрита с варовик	/ Сменете гилзата
/ Арматурата капе	/ Дефектна гилза	/ Сменете гилзата
/ Избиване на вода от закрепващата шийка	/ Съвързващите маркучи не са напълно завинтени в основното тяло	/ Затегнете на ръка съвързващите маркучи
	/ Дефектен О-образен пръстен на съвързващия маркуч	/ Смяна на О-образен пръстен
/ Твърде ниска температура на водата	/ Ограничението за топлата вода е грушно настроено	/ Настройте ограничението за топлата вода

△ UDHËZIME SIGURIE

- △ Për të evituar lëndimet e pickimeve ose të prerjeve gjatë procesit të montimit duhet që të vishni doreza.
- △ Ndryshimet e mëdha të presionit mes lidhjeve të ujit të ftohtë dhe atij të ngrohtë duhen ekuilibruar.

UDHËZIME PËR MONTIMIN

- / Përpara montimit duhet që produkti të kontrollohet për dëmtime nga transporti. Pas instalimit nuk do të njihet asnjë dëmtim nga transporti ose dëmtim i sipërfaqes.
- / Tubacionet dhe rubinetet duhet që të montohen, të shpëlahen dhe të kontrollohen sipas standardeve në fuqi
- / Duhet të respektohen linjat udhëzuese të instalimit, të vlefshme për vendet respektive.
- / 12803000: Armatura nuk mund të përdoret në kombinim me një ngrohës elektrik të ujit.

TË DHËNA TEKNIKE

Presioni gjatë punës	maks. 1 MPa
Presioni i rekomanduar:	0,1 - 0,5 MPa
Presioni për provë:	1,6 MPa
	(1 MPa = 10 bar = 147 PSI)
Temperatura e ujit të ngrohtë	maks. 70°C
Temperatura e rekomanduar e ujit të ngrohtë:	65°C
Dezinfektim Termik:	maks. 70°C / 4 min
Produkti është projektuar ekskluzivisht për ujë të pijshëm!	

PËRSHKRIMI I SIMBOLIT



Mos përdorni silikon që në përbërje ka acid acetik.



PËRMASAT (shih faqen 35)



DIAGRAMI I QARKULLIMIT (shih faqen 36)



PASTRIMI (shih faqen 38)



MIRËMBAJTJA (shih faqen 39)

Penguesit e rrjedhjes në drejtim të kundërt duhen kontrolluar rregullisht në bazë të normave DIN EN 1717 konform normave nacionale dhe regjionale (së paku një herë në vit).



PJESËT E SERVISIT (shih faqen 40)

PAJISJE TË POSAÇME (nuk përfshihet në vëllimin e furnizimit)



/ set i nivelimit #97474000 (shih faqen 32)



/ Përshtatësi (G¹/₂ / G³/₄) #93395000 (shih faqen 41)



PËRDORIMI (shih faqen 37)

Hansgrohe rekomandon që në mëngjes ose pas periudhave të gjata që gjysmë litri i parë mos të pihet



SHENJA E KONTROLLIT (shih faqen 42)

DEMTIM	SHKAKU	NDIHME
/ Armatura punon rende	/ Kartusha me defekt, me kalk	/ Kembeni kartushen
/ Armatura pikon	/ Kartusha me defekt	/ Kembeni kartushen
/ Dalje e ujit ne cilindrin fiksues	/ Tubat e lidhjes jo komplet te vidhosur ne karkasen baze	/ Shtrengojini manualisht tubat e lidhur
	/ Unaza O tek tubi lidhes me defekt	/ Kembeni unazen O
/ Temperaturë e ulët e ujit të ngrohtë	/ Kufiri i ujit te ngrohte eshte regjistruar gabim	/ Regjistroni kufirin e ujit te ngrohte



وصف الرمز

هام! لا تستخدم السليكون الذي يحتوي على أحماض!



أبعاد (راجع صفحة 35)

رسم للصفحة (راجع صفحة 36)

التنظيف (راجع صفحة 38)

الصيانة (راجع صفحة 39)

يجب فحص صمام عدم الرجوع بصفة منتظمة حسب المواصفة DIN EN 1717 وذلك طبقاً للوائح الوطنية أو الإقليمية (مرة واحد سنوياً على الأقل).

قطع الغيار (راجع صفحة 40)

ملحقات خاصة (غير مدرج مع المحتويات المسلمة)

عدة التسوية #97474000 (راجع صفحة 32)

محول #93395000 (G¹/₂ / G³/₄) (راجع صفحة 41)

التشغيل (راجع صفحة 37)

تتصح شركة هانزجروهي Hansgrohe بعدم استخدام أول نصف لتر من الماء لغرض الشرب وذلك في الصباح أو بعد توقف استخدام الماء لفترات طويلة نسبياً.

شهادة اختبار (راجع صفحة 42)



تنبيهات الأمان

يجب إرتداء قفازات لليد أثناء التركيب لتجنب حدوث أخطار الإنحشار أو الجروح

يجب أن يكون تيار الماء الساخن والماء البارد متعادلين في الضغط

تعليمات التركيب

قبل القيام بعملية التركيب، يجب فحص المنتج للتأكد من خلوه من أية تلفيات ناتجة عن النقل بعد القيام بعملية التركيب، لن يتم الاعتراف بوجود أية تلفيات سطحية أو تلفيات ناتجة عن عملية النقل.

يجب تركيب وغسيل واختبار التوصيلات وخلطات المياه طبقاً للمعايير السارية.

يجب مراعاة القواعد الخاصة بالتركيب وأعمال السباكة وفقاً للوائح الخاصة بكل بلد.

12803000: لا يمكن استخدام خلط الماء مع جهاز تسخين الماء الفوري.

المواصفات الفنية

ضغط التشغيل: الحد الأقصى 1 ميجاباسكال

ضغط التشغيل الموصى به: 0,5 - 0,1 ميجاباسكال

ضغط الاختبار: 1,6 ميجاباسكال

(1 ميجاباسكال = 10 بار = 147 PSI)

درجة حرارة الماء الساخن: الحد الأقصى 70°C

درجة الحرارة الموصى بها للماء الساخن: 65°C

تعقيم حراري: الحد الأقصى 70°C / 4 الدقيقة

المنتج مخصص فقط لماء الشرب!

العطل	السبب	العلاج والإصلاح
/ الخلاط ثقيل الحركة	/ الخرطوشة تالفة، تراكم عليها الجير	/ قم بتغيير الخرطوشة
/ تساقط قطرات مياه من الخلاط	/ الخرطوشة تالفة	/ قم بتغيير الخرطوشة
/ خروج الماء من جزء التثبيت	/ خراطيم التوصيل ليست مربوطة في الجزء الرئيسي بشكل كامل	/ اربط خراطيم التوصيل بيدك
/ درجة حرارة الماء الساخن منخفضة	/ الحلقة الدائرية الخاصة بخراطيم التوصيل تالفة	/ قم بتغيير الحلقة الدائرية
/ درجة حرارة الماء الساخن منخفضة للغاية	/ محدد الماء الساخن مضبوط بشكل خاطئ	/ قم بضبط محدد الماء الساخن



التركيب (راجع صفحة 32)

△ BIZTONSÁGI UTASÍTÁSOK

- △ A szerelésnél a zúzódások és vágási sérülések elkerülése érdekében kesztyűt kell viselni.
- △ A hidegvíz- és a melegvíz-csatlakozások közötti nagy nyomáskülönbséget kicell egyenlíteni!

SZERELÉSI UTASÍTÁSOK

- / A szerelés előtt ellenőrizni kell, hogy a terméknek nincs-e szállítási sérülése. Beépítés után a szállítási- vagy felületi sérüléseket nem ismerik el.
- / A vezetékeket és a csaptelepet az érvényes szabványoknak megfelelően kell felszerelni, öblíteni és ellenőrizni
- / Az egyes országokban érvényes installációs irányelveket be kell tartani.
- / 12803000: A vízcsapot nem lehet átfolyós vízmelegítővel használni.

MŰSZAKI ADATOK

Üzemi nyomás:	max. 1 MPa
Ajánlott üzemi nyomás:	0,1 - 0,5 MPa
Nyomáspróba:	1,6 MPa
	(1 MPa = 10 bar = 147 PSI)
Forróvíz hőmérséklet:	max. 70°C
Forróvíz javasolt hőmérséklete:	65°C
Termikus fertőtlenítés:	max. 70°C/4 perc

A terméket kizárólag ivóvízhez tervezték!

SZIMBÓLUMOK LEÍRÁSA

 Ne használjon ecetsavtartalmú szilikon!

 MÉRÉTERET (lásd a oldalon 35)

 ÁTFOLYÁSI DIAGRAMM (lásd a oldalon 36)

 TISZTÍTÁS (lásd a oldalon 38)

 KARBANTARTÁS (lásd a oldalon 39)

A visszafolyásgátlók működése a DIN EN 1717 szabványnak megfelelően, a nemzeti vagy területi rendelkezésekkel összhangban, évente egyszer ellenőrizendő!

 TARTOZÉKOK (lásd a oldalon 40)

EGYÉB TARTOZÉK
(a szállítási egység nem tartalmazza)

 / szintező készlet #97474000 (lásd a oldalon 32)

 / Adapter (G $\frac{1}{2}$ /G $\frac{3}{4}$) #93395000 (lásd a oldalon 41)



HASZNÁLAT (lásd a oldalon 37)

- / A csaptelepeken átfolyt víz hőmérséklete fogyasztásra szánt víz esetében a 65°C-ot nem haladhatja meg. A csaptelep nem eredményezheti az emberi fogyasztásra (pl. ivás és főzés céljából) szánt víz minőségromlását.
- / Beüzemelés és üzemszünetek után szigorúan be kell tartani a használati útmutatóban leírtakat. Beüzemeléskor a csaptelepet át kell öblíteni, legalább 2 percig történtő hideg- és melegvízes folyamatot javasunk. Minimum 1 napos üzemszünet után fogyasztás előtt a csaptelepben stagnáló hideg- illetve melegvíz fogyasztása nem javasolt, a csaptelepben stagnáló vizet ki kell engedni, legalább 2 perces folyamat javasolt. A kifolytatás során nyert vizet ivóvízként, illetve ételkészítési céllal felhasználni nem szabad.
- / Tekintettel arra, hogy a forró víz fémoldó képessége a hideg víznél nagyobb, emiatt főzés ivás céljából az OKI a hideg víz használatát javasolja.
- / A csaptelepek perlatorát javasolt havonta vízköteníteni, illetve fertőtleníteni. A csaptelepek tisztítása, fertőtlenítése során kizárólag olyan vegyszer alkalmazható, amely megfelel a 201/2001. (X.25) Kormányrendelet, illetve a 38/2003. (VII.7) ÉSzCsM-FVM-KvVM együttes rendeletben leírtaknak.
- / A perlator működési elvéből adódóan jelentős aeroszolt képez, így Legionella expozíció szempontjából fokozott kockázatot jelent. Ezért alkalmazása nem javasolt az egészségügyi intézmények fekvőbeteg ellátó szobáiban, illetve minden olyan helyen, ahol a hideg és/vagy használati melegvíz Legionella csíraszám eléri a 49/2015 (XI.6.) EMMI rendelet alapján meghatározott beavatkozási szintet.



VIZSGAJEL (lásd a oldalon 42)

HIBA	OK	MEGOLDÁS
/ Nehezen nyitható a csap.	/ A kerámiabetét meghibásodott, elvizesedett.	/ A kerámiabetétet ki kell cserélni.
/ Csöpög a csap.	/ A kerámiabetét meghibásodott.	/ A kerámiabetétet ki kell cserélni.
/ Vízkilépés a rögzítőrúdon	/ A csatlakozótömlők nincsenek teljesen becsavarozva az akaptestbe	/ A csatlakozótömlőket kézzel meghúzni
	/ Csatlakozótömlő tömítőgyűrűje meghibásodott	/ Tömítőgyűrű kicserélése
/ túl alacsony melegvíz hőmérséklet	/ A melegvíz szabályozó rosszul van beállítva.	/ A melegvíz szabályozót újra be kell állítani.



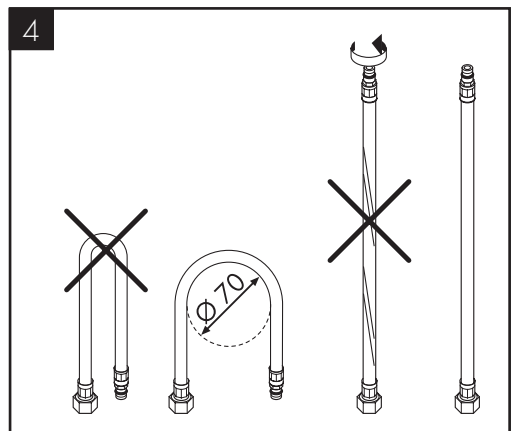
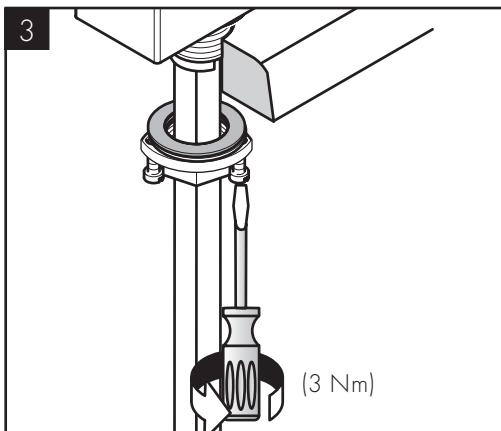
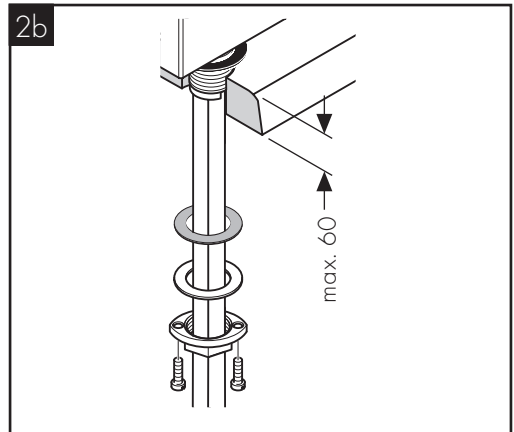
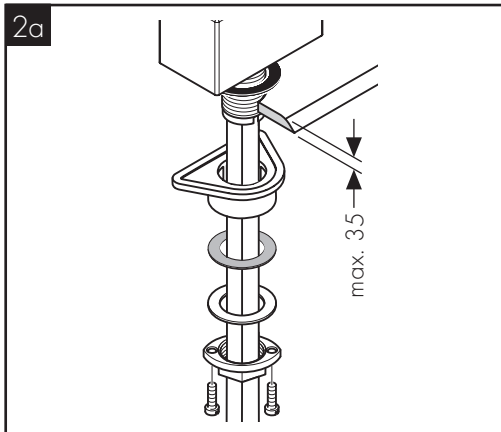
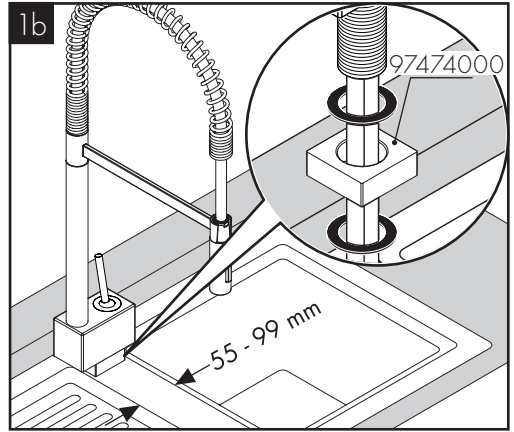
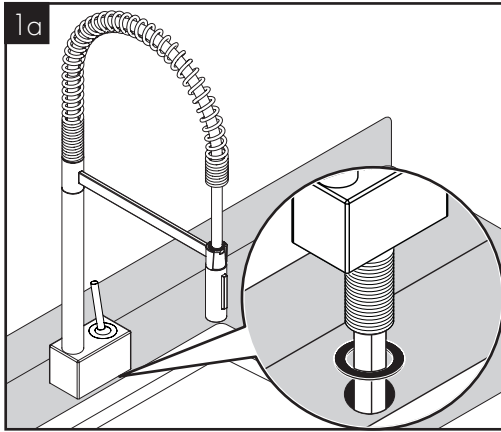

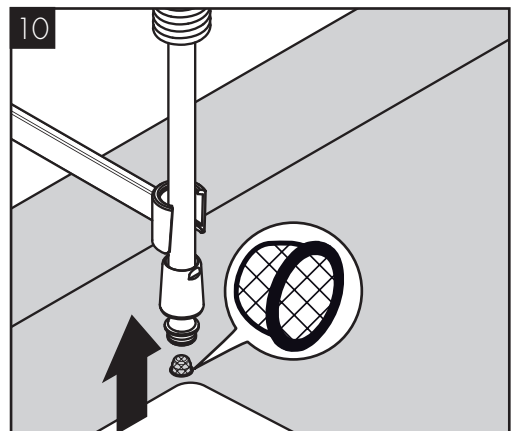
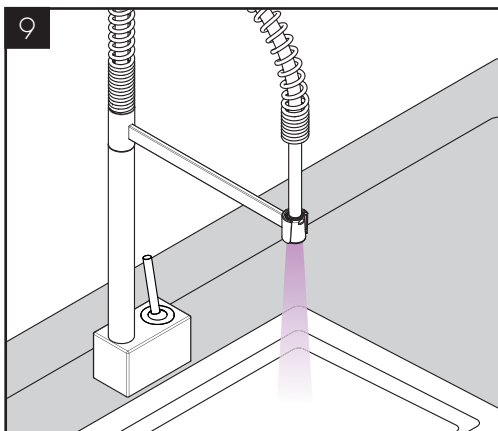
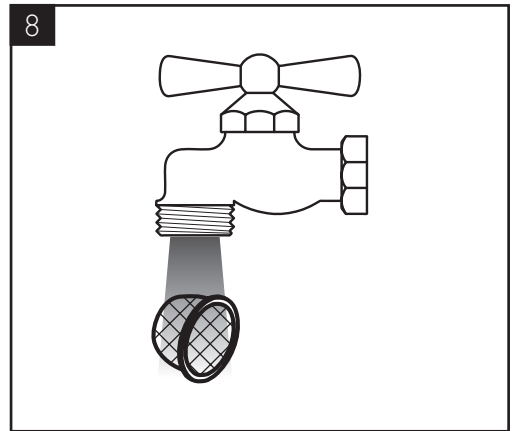
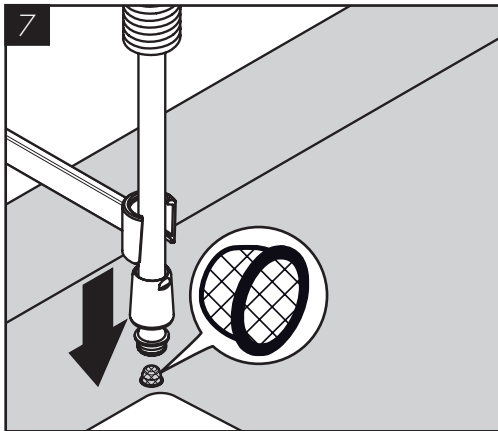
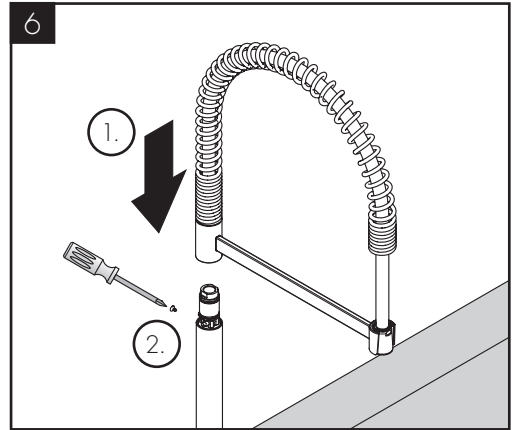
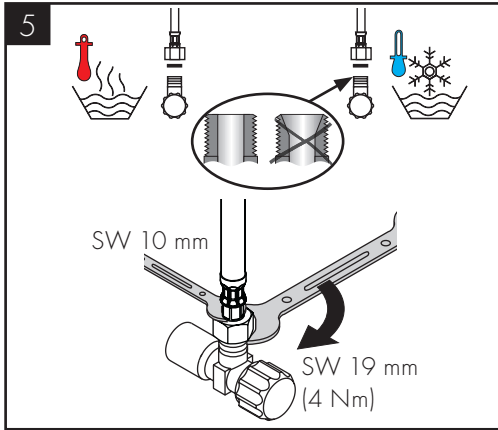

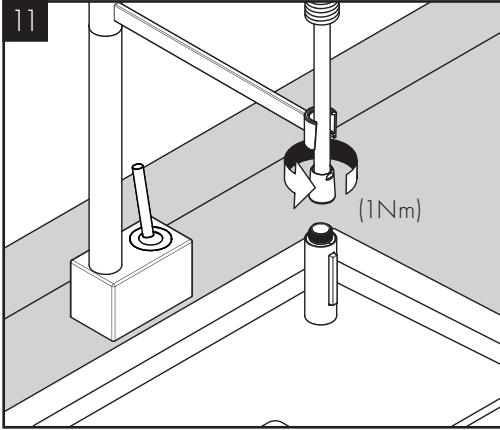



AXOR Starck Semi-Pro
10820000

AXOR Starck Semi-Pro Eco
12803000

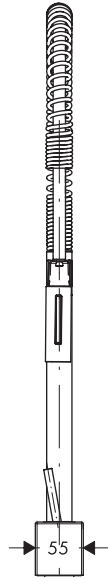
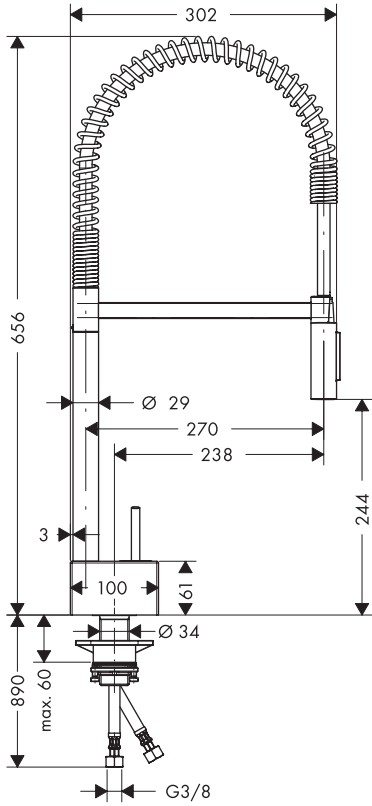

97474000
(not included!)

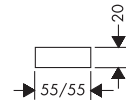



AXOR Starck Semi-Pro

10820000

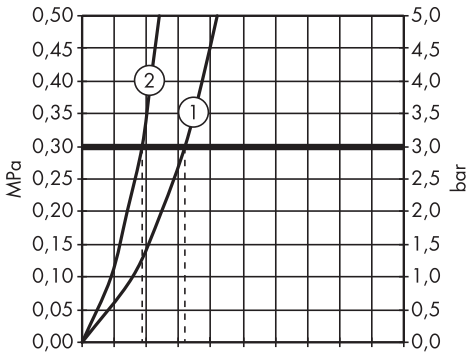

Q = l/min 0 3 6 9 12 15 18 21 24 27 30
 Q = l/sec 0 0,1 0,2 0,3 0,4 0,5

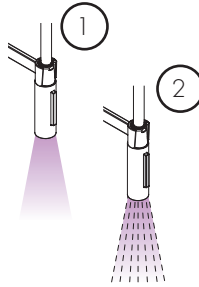

AXOR Starck Semi-Pro Eco

12803000

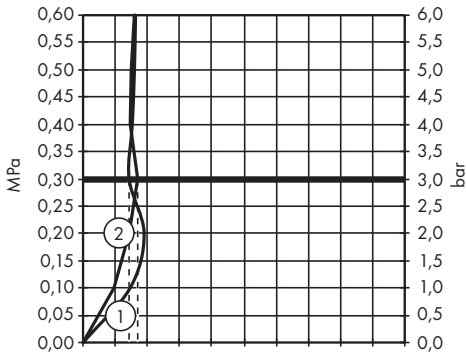

Q = l/min 0 3 6 9 12 15 18 21 24 27 30
 Q = l/sec 0 0,1 0,2 0,3 0,4 0,5

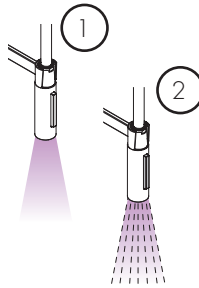

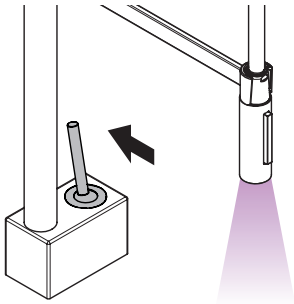

öffnen / ouvert / open / aperto / abierto / open / åbne / abrir /
otworzyć / otevřít / otvorit / 开 / открыть / nyitás / avaaminen /
öppna / atidaryti / Otvaranje / açmak / deschide / ανοικτό /
odpreti / avage / atvērt / otvoriti / åpne / отварање / hare /
فتح

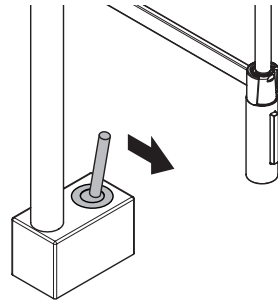

schließen / fermé / close / chiudere / cerrar / sluiten / lukke /
fechar / zamknąć / zavřít / uzavrieť / 关 / закрыть / bezárás /
sulkeminen / stänga / uždaryti / Zatvaranje / kapatmak /
ínchide / κλειστό / zapreti / sulgege / aizvērt / zatvori / lukke /
затварање / mbylle / إغلاق

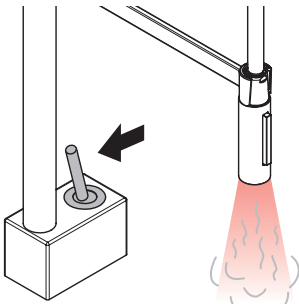

warm / chaud / hot / caldo / caliente / warm / varmt / quente /
ciepla / teplá / teplá / 热 / горячая / meleg / lämmin / varmt /
karštas / Vruća voda / sıcak / cald / ζεστό / toplo / kuum /
karsts / topla / varm / тепло / i ngrohtë / ساخن

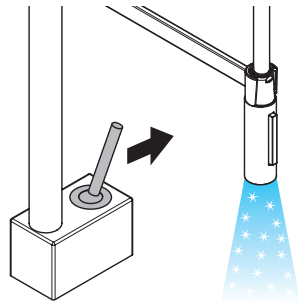

kalt / froid / cold / freddo / frío / koud / koldt / fria / zimna /
studená / studená / 冷 / холодная / hideg / kylmä / kallt /
šaltas / Hladno / soğuk / rece / κρύο / mrzlo / külm / auksts /
hladno / kaldt / студено / i fjohtë / بارد

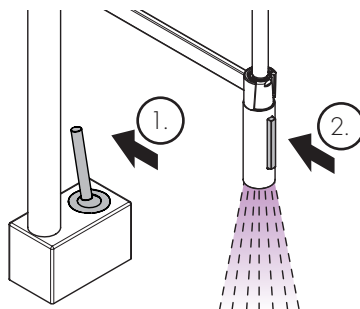

öffnen / ouvert / open / aperto / abierto / open / åbne / abrir /
otworzyć / otevřít / otvorit / 开 / открыть / nyitás / avaaminen /
öppna / atidaryti / Otvaranje / açmak / deschide / ανοικτό /
odpreti / avage / atvērt / otvoriti / åpne / отварање / hare /
فتح



- DE / Reinigungsempfehlung / Garantie / Kontakt
FR / Recommandation pour le nettoyage / Garanties / Contact
EN / Cleaning recommendation / Warranty / Contact
IT / Raccomandazione di pulizia / Garanzia / Contatto
ES / Recomendaciones para la limpieza / Garantía / Contacto
NL / Aanbevelingen inzake reiniging / Garantie / Contact
DK / Rensning, anbefaling / Garanti / Kontakt
PT / Recomendações de limpeza / Garantia / Contacto
PL / Zalecenie dotyczące pielęgnacji / Gwarancja / Kontakt
CS / Doporučení k čištění / Záruka / Kontakt
SK / Odporúčania pre čistenie / Záruka / Kontakt
ZH / 清洁指南 / 担保 / 接触
RU / Рекомендации по очистке / Гарантия / Контакты
HU / Tisztítási tanácsok / Garancia / érintkezés
FI / Puhdistussuositus / Takuu / Kosketus
SV / Rengöringsrekommendationer / Garanti / Contacto
LT / Valymo rekomendacijos / Garantija / Kontaktai
HR / Preporuke za čišćenje / Garancija / Kontakt
TR / Temizleme önerisi / Garanti / Temas
RO / Recomandări pentru curățare / Garanție / Contact
EL / Σύσταση καθαρισμού / Εγγύηση / επαφή
SL / Priporočilo za čišćenje / Garancija / Kontakt
ET / Puhastussuovitused / Garantii / Kontakt
LV / Tīrīšanas ieteikumi / Garantija / Kontakti
SR / Preporuke za čišćenje / Garancija / Kontakt
NO / Anbefaling for rengjøring / Garanti / Kontakt
BG / Препоръка за почистване / Гаранция / Контакт
SQ / Këshilla rreth pastrimit / Garancia / Kontakt
KO / 세정시 권장사항 / 품질보증 / 접촉
AR / توصيات التنظيف / الضمان (الولايات المتحدة الأمريكية) / اتصال



[www.axor-design.com/
cleaning-recommendation](http://www.axor-design.com/cleaning-recommendation)

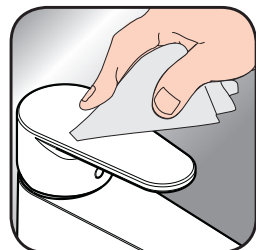

[www.axor-design.com/
cleaning-recommendation](http://www.axor-design.com/cleaning-recommendation)



[www.axor-design.com/
cleaning-recommendation](http://www.axor-design.com/cleaning-recommendation)



[www.axor-design.com/
cleaning-recommendation](http://www.axor-design.com/cleaning-recommendation)

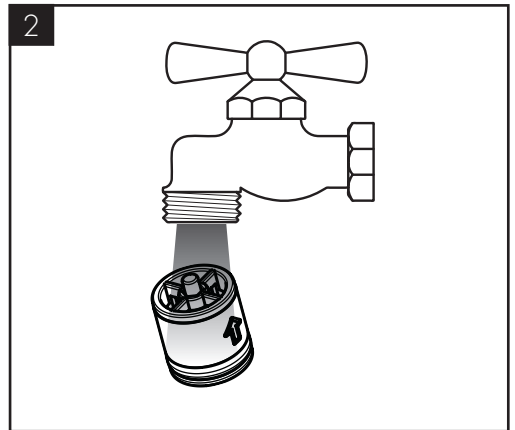
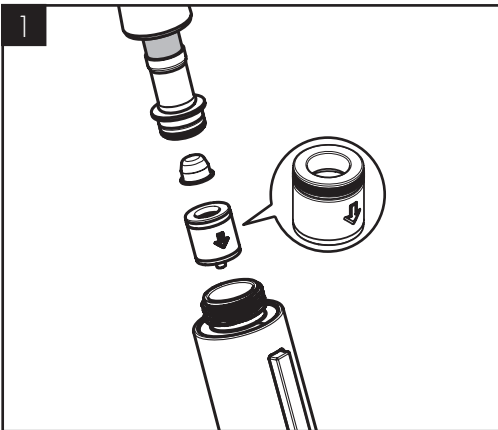
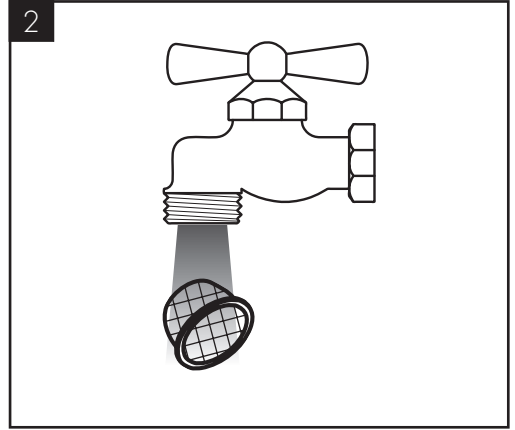
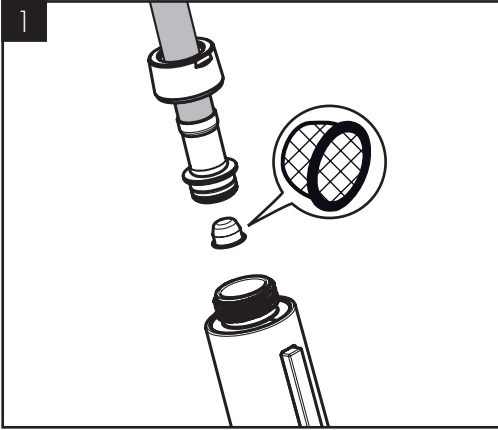



AXOR Starck Semi-Pro
10820000

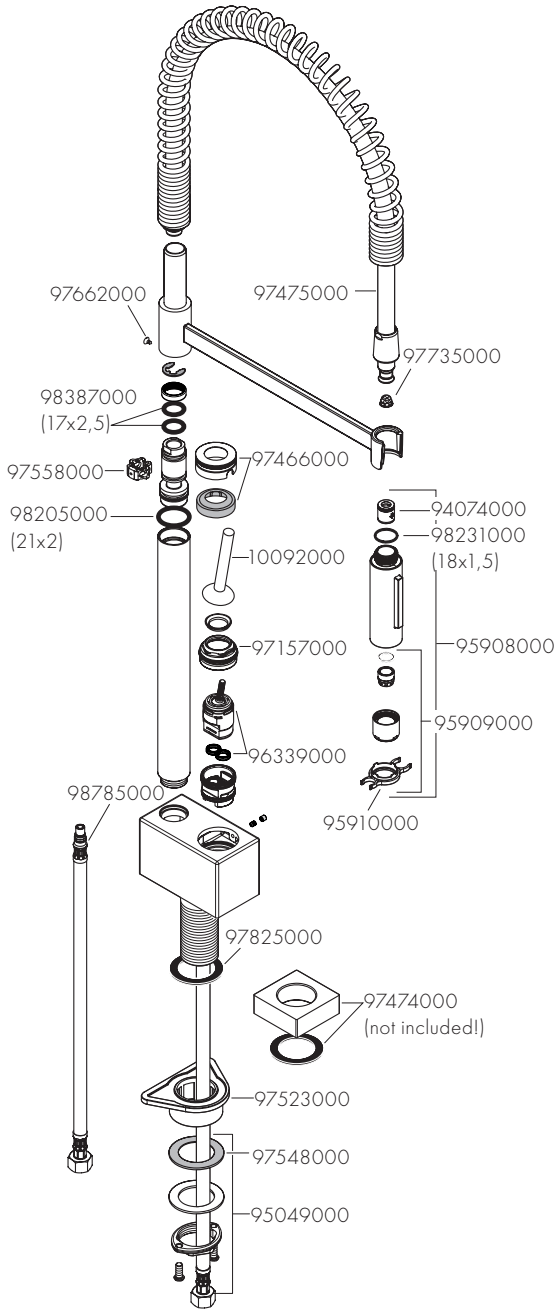



AXOR Starck Semi-Pro Eco
12803000

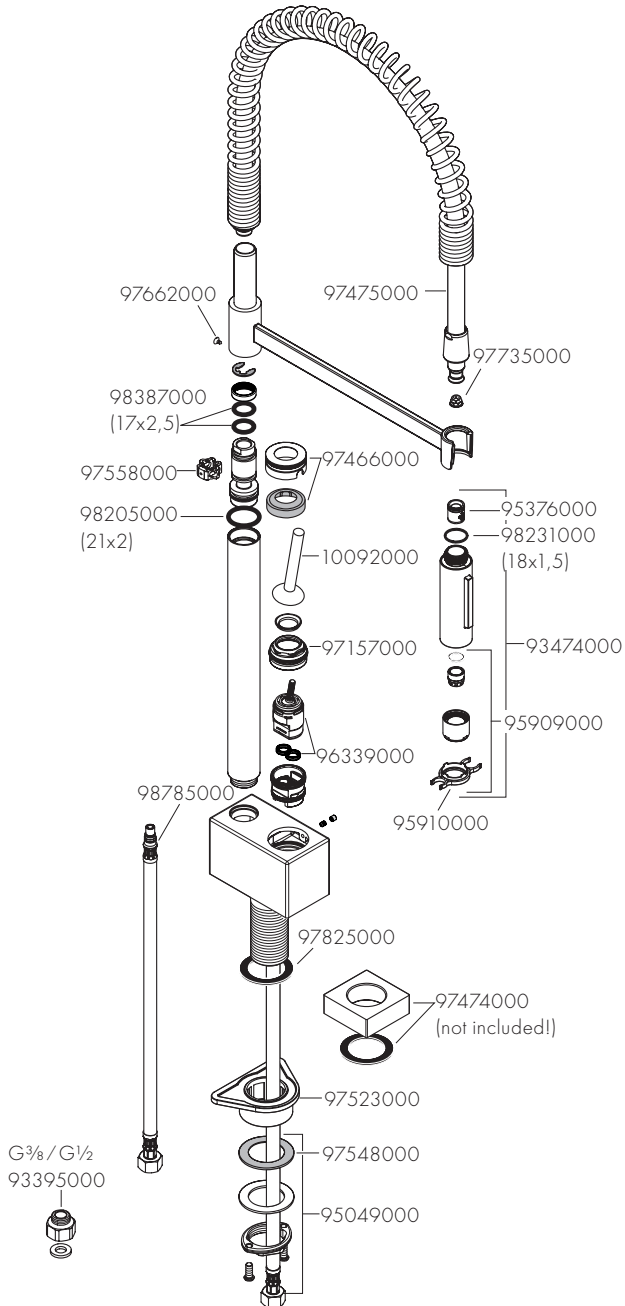



42

P-IX

DVGW

NF



ETA



GODKENDT
TIL DRILLEKVVAND

10820000 P-IX 18112/1AO

X

va 1.42/17904

12803000



AXOR

AXOR / Hansgrohe SE
Austraße 5-9
77761 Schiltach
Deutschland

info@axor-design.com
axor-design.com

12/2019
9.05418.08