













13 420 979 Produktversion ab 01.04.2023



- Ausladung 120 mm
- CASCADE, Durchfluss max. 26,5 l/min (bei 3 Bar)
- Abdeckplatte 240 x 60 mm
- Anschluss 1/2"
- Steckanschluss-Montage

| | | |
|---|---------------------------------|---------------|
|  | Chrom gebürstet | 13 420 979-93 |
|  | Chrom | 13 420 979-00 |
|  | Platin gebürstet | 13 420 979-06 |
|  | Platin | 13 420 979-08 |
|  | Dark Chrome | 13 420 979-19 |
|  | Light Gold | 13 420 979-26 |
|  | Light Gold gebürstet | 13 420 979-27 |
|  | Messing gebürstet (23kt Gold) | 13 420 979-28 |
|  | Schwarz matt | 13 420 979-33 |
|  | Bronze gebürstet | 13 420 979-42 |
|  | Champagne gebürstet (22kt Gold) | 13 420 979-46 |
|  | Champagne (22kt Gold) | 13 420 979-47 |
|  | Cyprum | 13 420 979-49 |
|  | Dark Platinum gebürstet | 13 420 979-99 |

13 420 979 Produktversion ab 01.04.2023

mm [inches]

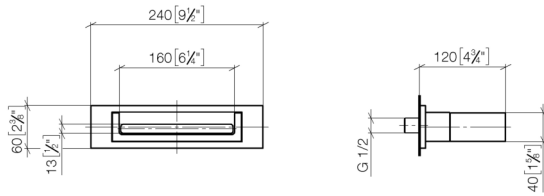

Durchflussdiagramm

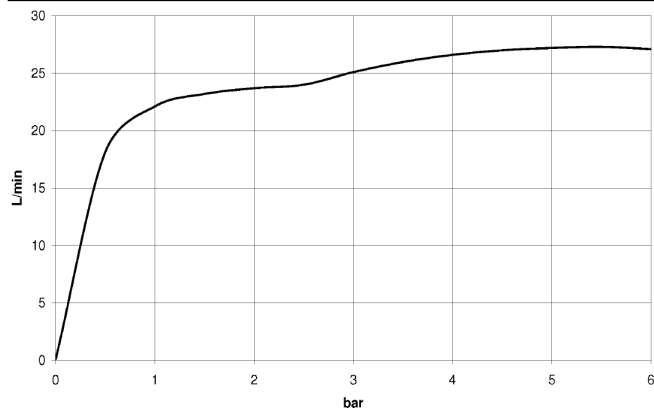

Wurfweitendiagramm

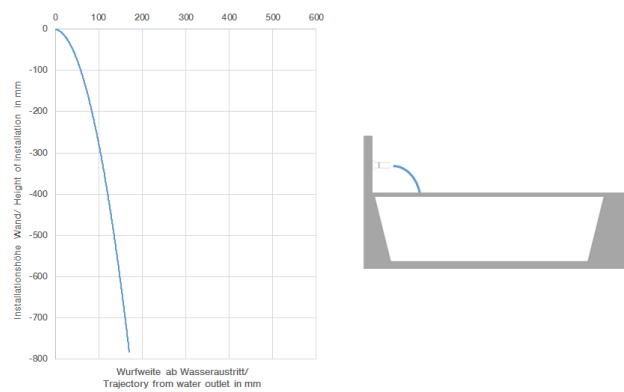

Codes & Standards

ASME A112.18.1

cUPC

DIN 4109

ISO 3822

Ü-Zeichen



WATER FALL Schwallauslauf für Wandmontage - Chrom gebürstet

SERIENNEUTRAL

13 420 979 Produktversion ab 01.04.2023

Zertifikate

LGA_18

IAPMO_4976

13 420 979 Produktversion ab 01.04.2023

Ersatzteile für die
anderen
Oberflächenvarianten
finden Sie hier:
Chrom

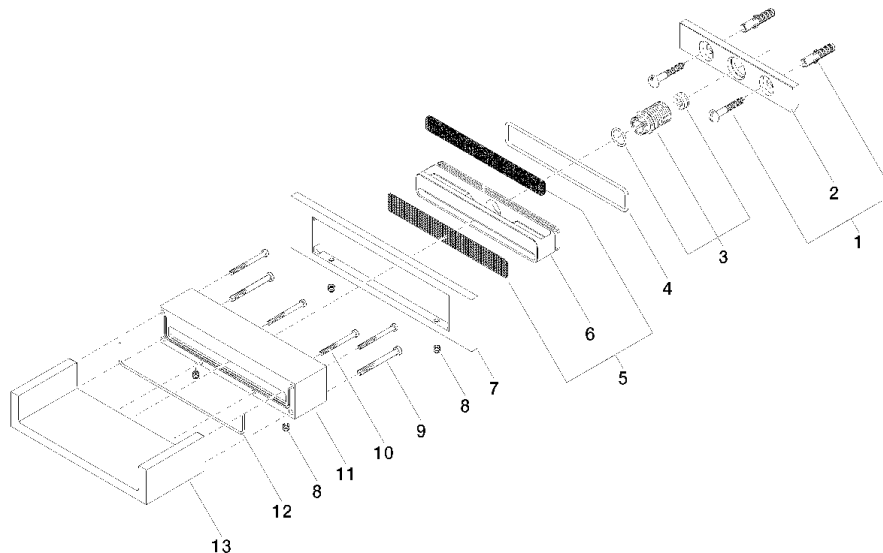

Ersatzteilstückliste

| Nr. | Artikelnummer | Benennung | Verbaumenge | Lieferzeit |
|-----|--------------------|--|-------------|------------|
| 11 | 09 30 01 104-93 | Gehäuse | 1,00 | 60 |
| 4 | 09 14 10 504 90 | O-Ring NBR 70 106 x 3 mm - | 1,00 | 2 |
| 12 | 09 14 03 504 90 | Dichtung Ø 2 x 205 mm - | 1,00 | 2 |
| 9 | 09 30 30 147 90 | Befestigung Zylinderschraube mit Innensechskant niedriger Kopf M5 x 50 mm - | 2,00 | 2 |
| 8 | 09 31 11 049 90 | Befestigung Gewindestift mit Innensechskant mit Ringschneide M6 x 6 mm - | 4,00 | 2 |
| 6 | 09 17 11 044 20 90 | Befestigung für Water Fall Verteiler 163 x 26 x 30,5 mm - | 1,00 | 2 |
| 5 | 90 29 30 040 00 90 | WaterFall Einsatz Sieb 158,6 x 20,70 x 0,8 mm - | 1,00 | 2 |
| 7 | 09 27 97 034-93 | Rosette | 1,00 | 60 |
| 13 | 09 11 94 046-93 | Auslauf | 1,00 | 60 |
| 3 | 90 24 05 008 00 90 | Nippel Ø 23 x 35 mm - | 1,00 | 2 |
| 2 | 09 17 97 056 90 | Halter 145 x 30 x 8 mm - | 1,00 | 2 |
| 1 | 04 30 31 024 01 90 | Befestigungssatz Holzschraube mit Dübel 6 x 40 mm - | 1,00 | 2 |
| 10 | 09 30 30 086 90 | Befestigung Zylinderschraube mit Innensechskant niedriger Kopf M4 x 45 mm - | 4,00 | 2 |