



























28 016 979 Produktversion ab 01.04.2024



- Dreifach bzw. fünffach verstellbar: COMPACT RAIN, COMPACT SOFT FLOW, COMPACT AQUAPRESSURE FLOW, Durchfluss max. 15 l/min (bei 3 Bar)
- mit Antikalk-System
- Brausekopf Ø 130 mm
- Anschluss 1/2"

Eigensicher gegen Rückfließen.

	Light Gold gebürstet	28 016 979-27
	Chrom	28 016 979-00
	Chrom	28 016 979-00 0010
	Platin gebürstet	28 016 979-06
	Platin gebürstet	28 016 979-06 0010
	Platin	28 016 979-08 0010
	Platin	28 016 979-08
	Weiß matt	28 016 979-10
	Weiß matt	28 016 979-10 0010
	Dark Brass matt	28 016 979-16 0010
	Dark Brass matt	28 016 979-16
	Dark Bronze matt	28 016 979-17 0010
	Dark Bronze matt	28 016 979-17
	Dark Chrome	28 016 979-19 0010
	Dark Chrome	28 016 979-19
	Light Gold	28 016 979-26
	Light Gold	28 016 979-26 0010
	Light Gold gebürstet	28 016 979-27 0010
	Messing gebürstet (23kt Gold)	28 016 979-28 0010
	Messing gebürstet (23kt Gold)	28 016 979-28
	Schwarz matt	28 016 979-33
	Schwarz matt	28 016 979-33 0010
	Bronze gebürstet	28 016 979-42 0010
	Bronze gebürstet	28 016 979-42
	Champagne gebürstet (22kt Gold)	28 016 979-46
	Champagne gebürstet (22kt Gold)	28 016 979-46 0010

 Champagne (22kt Gold)	28 016 979-47 0010
 Champagne (22kt Gold)	28 016 979-47
 Chrom gebürstet	28 016 979-93
 Chrom gebürstet	28 016 979-93 0010
 Dark Platinum gebürstet	28 016 979-99
 Dark Platinum gebürstet	28 016 979-99 0010

28 016 979 Produktversion ab 01.04.2024

mm [inches]

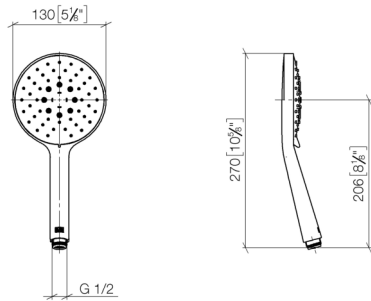

**Durchflussdiagramm**

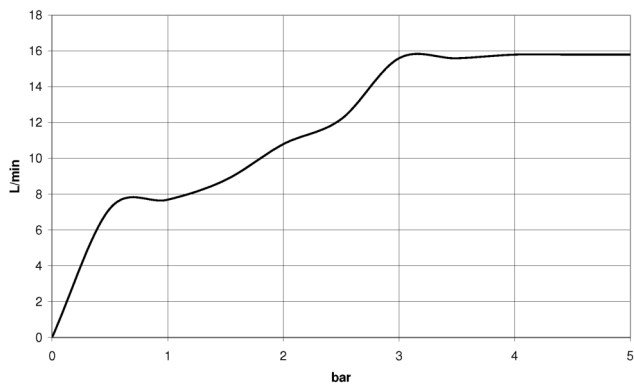

**Codes & Standards**

DIN 4109

ISO 3822

Ü-Zeichen



## Handbrause - Light Gold gebürstet

SERIENNEUTRAL

28 016 979 Produktversion ab 01.04.2024

### Zertifikate

LGA\_29

28 016 979 Produktversion ab 01.04.2024

Ersatzteile für die  
anderen  
Oberflächenvarianten  
finden Sie hier:  
Chrom

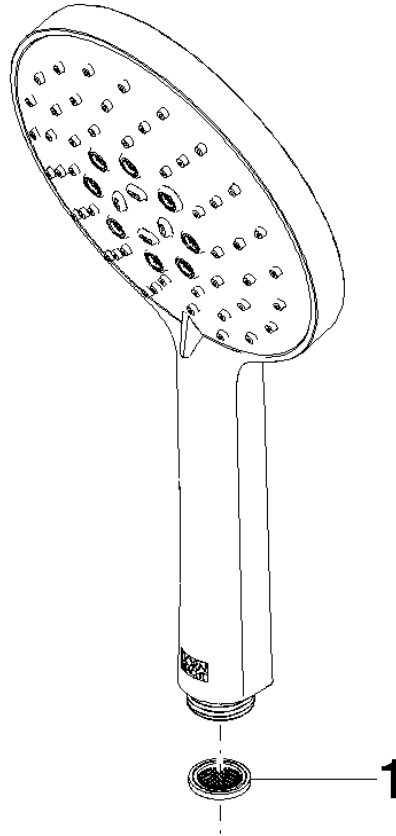

### Ersatzteilstückliste

Nr.	Artikelnummer	Benennung	Verbaumenge	Lieferzeit
1	09 23 01 039 90	Siebichtung Ø 19 x 5,5 mm -	1,00	2