

**DE** Montageanleitung**EN** Mounting instruction**ES** Instrucciones de instalación**FR** Instructions d'installation**IT** Istruzioni per l'installazione**NL** Montagehandleiding**CS** Návod k instalaci**PL** Instrukcja montażu**RU** Инструкция по монтажу

59541 010201    59541 030201  
 59541 050201    59541 070201  
 59541 130201    59541 170201  
 59541 370201

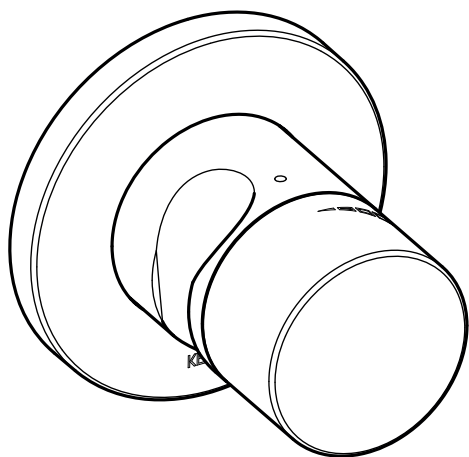

59541 010202    59541 030202  
 59541 050202    59541 070202  
 59541 130202    59541 170202  
 59541 370202

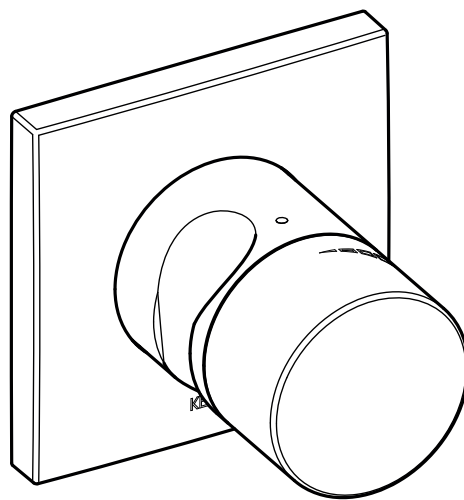
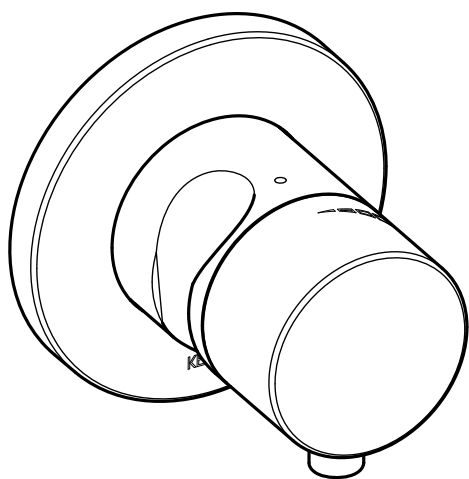

59541 011201    59541 031201  
 59541 051201    59541 071201  
 59541 131201    59541 171201  
 59541 371201

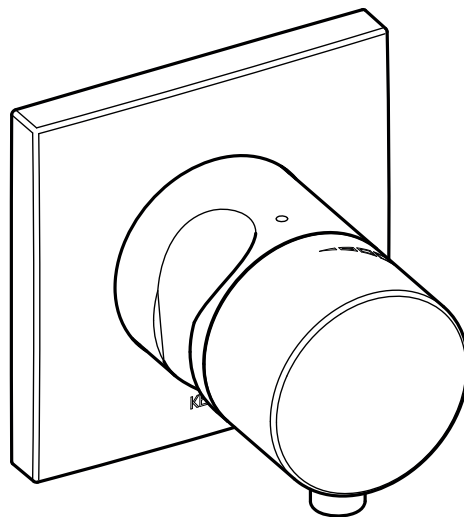

59541 011202    59541 031202  
 59541 051202    59541 071202  
 59541 131202    59541 171202  
 59541 371202

**DE** Einbaumaße

**FR** Cotes de montage

**CS** Montážní rozměry

**EN** Mounting dimensions

**IT** Ingombro

**PL** Wymiary montażowe

**ES** Dimensiones de montaje

**NL** Montageafmetingen



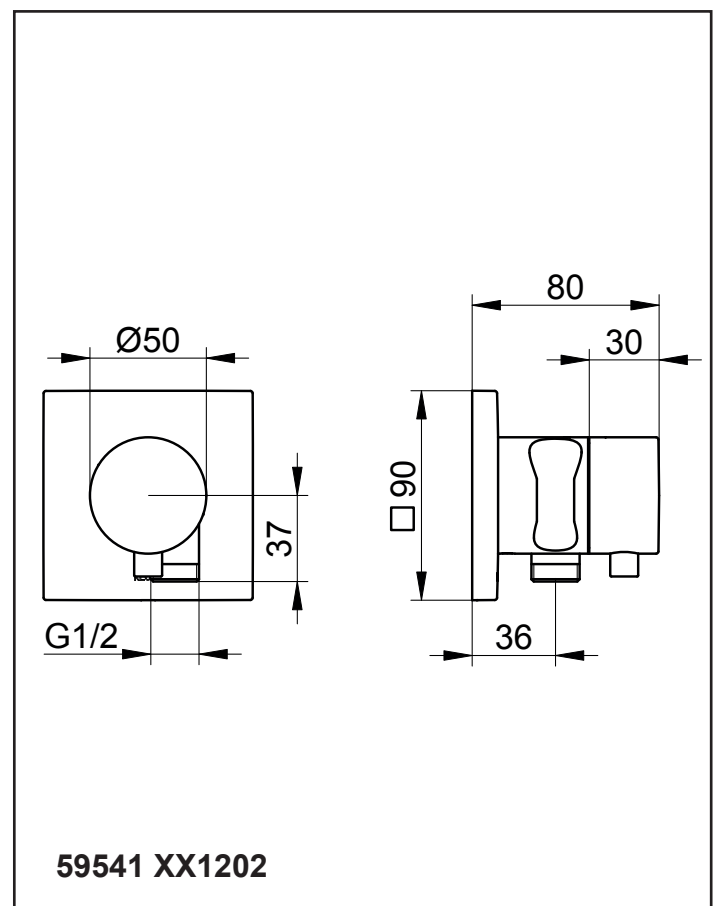
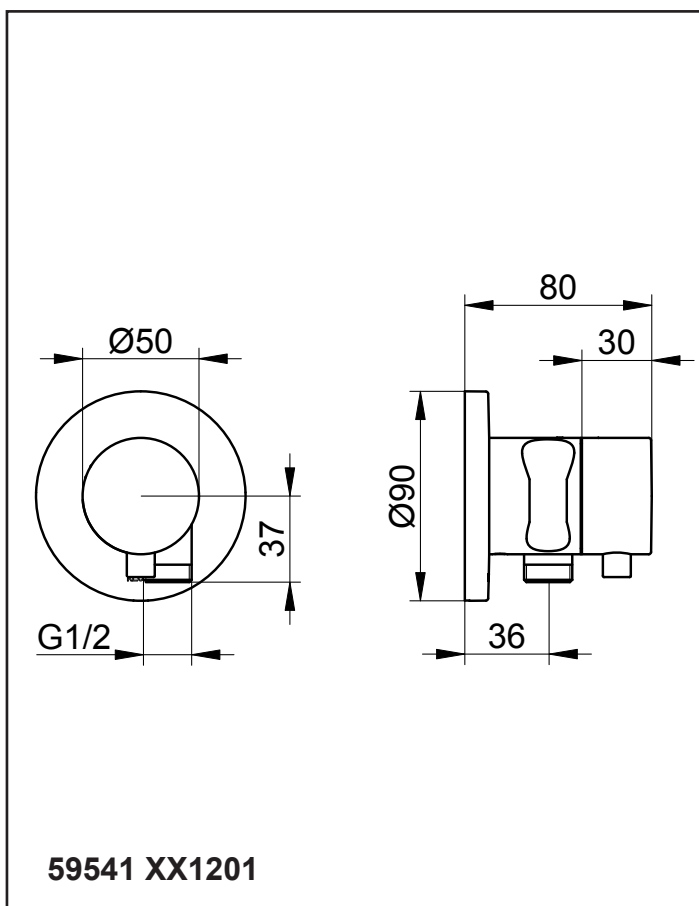
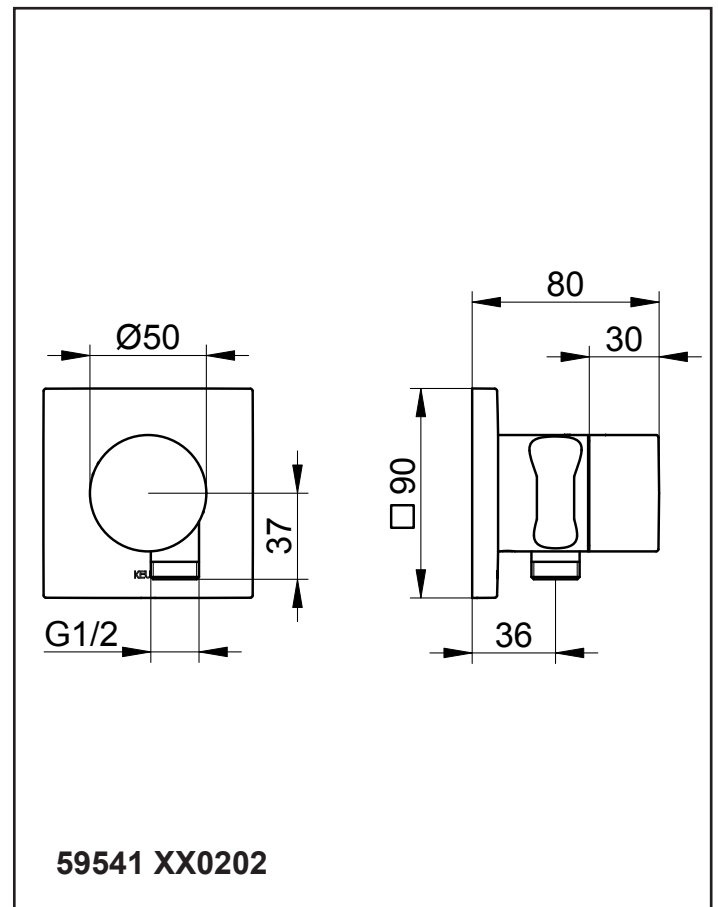
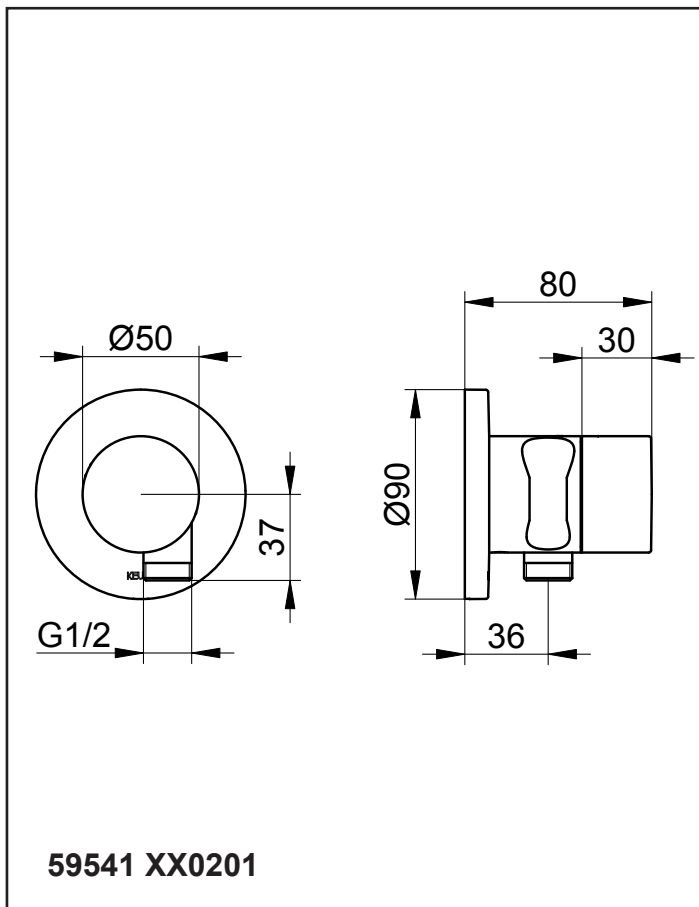







**RU** Монтажные размеры













 Diese Anleitung ist für den Installateur zur Montage sowie für den Nutzer zur Bedienung und Wartung des Produktes. Bitte nach der Installation an den Nutzer zur Verwahrung weitergeben.

 These instructions are for both the installer for installation and the user for operation and maintenance of the product. After installation, please hand them over to the user to keep.

**Symbole und Bedeutung**

-  **Achtung!** Warnung vor Personen- oder Sachschaden.
-  Hinweis, Tipp oder Verweis
-  Korrekte Montage/Funktionsprüfung
-  Falsche Montage
-  Montagedetail beachten
-  Kaltwasser       Warmwasser
-  Wasserfluss       Kein Wasserfluss
-  Optional/Zubehör

**Symbols and explanations**

-  **Attention!** Warning against bodily injury or damage to property.
-  Note, tip or reference
-  Correct installation/test of functionality
-  Incorrect installation
-  Observe installation details
-  Cold water       Hot water
-  Water flow       No water flow
-  Optional/accessories

**Technische Daten**

Durchfluss bei 3 bar Fließdruck: ca. 12 l/min

**Technical specifications**

Flow at 3 bar pressure: approx. 12 l/min

**Einbaumaße**, siehe Seite 2

**Installation dimensions**, refer to page 2

**Installation**, siehe ab Bild 1 auf Seite 8

 Nur neutral vernetzendes Silikon verwenden.

**Installation**, refer to picture 1 on page 8

 Use only neutrally netting silicone.

**Bedienung**, siehe Bild 9 auf Seite 10

**Operation**, refer to picture 9 on page 10

**Wartung**, siehe Bild 10 auf Seite 10

Montage in umgekehrter Reihenfolge.  
– Anzugsmoment Kartuschenmutter: 20-30 Nm

**Servicing**, refer to picture 10 on page 10

Assemble in reverse order.  
– Cartridge nut torque: 20-30 Nm

**Ersatzteile mit Bestellnummern**, siehe Seite 11

**For spare parts with order numbers**, refer to page 11

 Hinweise zur Gewährleistung und Pflege sind dem beiliegendem **Pflege- und Garantiepass** zu entnehmen.

 For warranty and care information please refer to the attached **warranty and care instructions**.

 Este manual está dirigido al instalador para el montaje, así como al usuario para el manejo y mantenimiento del producto. Por favor, después de la instalación, este manual se debe entregar al usuario para que lo conserve.

**Símbolos y significado**

 ¡Atención! Advertencia de daños personales o materiales.

 Indicación, consejo o referencia

 Montaje/comprobación de funcionamiento correctos

 Montaje erróneo

 Observar el detalle de montaje

 Agua fría

 Agua caliente

 Flujo de agua

 Ningún flujo de agua

 Opcional/Accesorios

**Datos técnicos**

Paso con una presión de caudal de 3 bares:  
aprox. 12 l/min.

**Medidas de montaje**, véase página 2

**Instalación**, véase imagen 1 en la página 8

 Utilizar exclusivamente silicona de reticulación neutra.

**Manejo**, véase imagen 9 en la página 10

**Mantenimiento**, véase imagen 10 en la página 10

El montaje se efectúa en el orden inverso.  
– Par de apriete de la tuerca de fijación del cartucho: 20-30 Nm

**Piezas de recambio con números de pedido**, véase página 11

 En el pasaporte de mantenimiento y garantía adjunto encontrará indicaciones sobre **la garantía y el mantenimiento**.

 Ces instructions sont destinées à l'installateur, pour effectuer le montage, et pour l'utilisateur, pour utiliser le produit et procéder à sa maintenance. Après l'installation, veuillez remettre ces instructions à l'utilisateur pour qu'il les conserve.

**Symboles et leur signification**

 **Attention !** Mise en garde contre les dégâts de personnes et les dégâts matériels.

 Remarque, conseil ou renvoi

 Montage correct/contrôle fonctionnel

 Montage incorrect

 Respecter le détail de montage

 Eau froide

 Eau chaude

 Débit d'eau

 Pas de débit d'eau

 Option/accessoires

**Caractéristiques techniques**

Débit à une pression d'écoulement de 3 bar :  
env. 12 l/mn

**Cotes d'encombrement**, voir page 2

**Installation**, voir figure 1 à la page 8

 N'utiliser que du silicone à réticulation neutre.

**Utilisation**, voir figure 9 à la page 10

**Maintenance**, voir figure 10, page 10

Le montage s'effectue dans l'ordre inverse de la dépose.

– Couple de serrage écrou de cartouche :  
20-30 Nm

**Pièces de rechange avec numéros de commande**, voir page 11

 Les consignes relatives à la garantie et à l'entretien figurent sur la carte **d'entretien et de garantie** jointe.

 Il presente manuale è indirizzato agli installatori per il montaggio nonché agli utilizzatori per l'uso e la manutenzione del prodotto. Consegnarlo all'utilizzatore dopo l'installazione affinché lo custodisca.

 Deze handleiding is bestemd voor zowel de installateur voor de montage alsook voor de gebruiker voor het gebruik en het onderhoud van het product. Gelieve na de installatie door te geven aan de gebruiker om te bewaren.

**Simboli e significato**

 **Attenzione!** Pericolo di lesioni o danni materiali.

 Avvertenza, consiglio o rimando

 Montaggio corretto/verifica del funzionamento

 Montaggio errato

 Prestare attenzione al dettaglio di montaggio

 Acqua fredda       Acqua calda

 Flusso d'acqua       Nessun flusso d'acqua

 Opzionale/accessorio

**Symbolen en betekenis**

 **Opgepast!** Gevaar voor letsel of schade.

 Opmerking, tip of referentie

 Correcte montage/werkingstest

 Verkeerde montage

 Montagedetails in acht nemen

 Koud water       Heet water

 Waterstroom       Geen waterstroom

 Optioneel/toebehoren

**Technische gegevens**

Doorstroming bij 3 bar stromingsdruk: ca. 12 l/min

**Inbouwafmetingen**, zie pagina 2

**Installatie**, zie vanaf afbeelding 1 op pagina 8

 Uitsluitend neutraal vernette siliconen gebruiken.

**Gebruik**, zie afbeelding 9 op pagina 10

**Onderhoud**, zie afbeelding 10 op pagina 10

Montage in omgekeerde volgorde.  
– Aandraaimoment moer voor cartouche: 20-30 Nm

**Wisselstukken met bestelnummers**, zie pagina 11

 Instructies voor de waarborg en het onderhoud vindt u in de meegeleverde **Onderhouds- en garantiokaart**.

**Dati tecnici**

Portata con pressione di flusso di 3 bar:  
circa 12 l/min

**Ingombro**, vedi pagina 2

**Installazione**, vedi dalla figura 1 a pagina 8

 Utilizzare solo silicone neutro.

**Uso**, vedi figura 9 a pagina 10

**Manutenzione**, vedi figura 10 a pagina 10











Eseguire il montaggio in ordine inverso.  
– Coppia del dado della cartuccia: 20-30 Nm

**Ricambi con numero d'ordine**, vedi pagina 11

 Indicazioni relative alla garanzia e al trattamento vanno desunte dalla **scheda allegata**.

 Tento návod slouží instalatérům při montáži a uživatelům při obsluze a údržbě produktu. Po nainstalování ho předejte uživateli, aby si ho mohl uschovat.

**Symbole a význam**

-  **Pozor!** Výstraha před zraněním a věcnými škodami.
-  Upozornění, tip nebo odkaz
-  Správná montáž / kontrola funkčnosti
-  Nesprávná montáž
-  Při montáži dbejte na tento detail
-  Studená voda       Teplá voda
-  Průtok vody       Žádný průtok vody
-  Volitelná výbava / příslušenství

**Technické údaje**

Průtok při průtokovém tlaku 3 bary: cca. 12 l/min

**Montážní rozměry** viz strana 2**Instalace** viz obrázek 1 na straně 8

 Používejte pouze neutrální silikon.

**Obsluha** viz obrázek 9 na straně 10**Údržba** viz obrázek 10 na straně 10











Montáž probíhá v obráceném pořadí.  
– Utahovací moment matice kartuše: 20-30 Nm

**Náhradní díly s objednáacími čísly** viz strany 11

 Pokyny týkající se záruky a péče najdete v přiloženém **Návodu k údržbě a záručním listu**.

 Instrukcja przeznaczona jest dla instalatora, zapewniając pomoc w zakresie montażu oraz dla użytkownika, informując go o sposobie obsługi i konserwacji produktu. Po instalacji należy przekazać instrukcję użytkownikowi, aby ją u siebie przechowywał.

**Symbole i znaczenie**

-  **Uwaga!** Ostrzeżenie przed uszkodzami osobowymi i materialnymi.
-  Informacja, dobra rada lub odsyłacz
-  Właściwy montaż / kontrola funkcjonowania
-  Niewłaściwy montaż
-  Należy stosować się do danych, dotyczących montażu
-  Woda zimna       Woda gorąca
-  Strumień wody       Brak strumienia wody
-  Opcje / Osprzęt

**Dane techniczne**

Przepływ w przypadku ciśnienia hydraulicznego 3 bar:      około 12 l/min

**Wymiary zabudowy**, patrz strona 2**Instalacja**, patrz rys. 1 na stronie 8

 Należy wykorzystywać wyłącznie silikon, ulegający naturalnemu usieciowaniu.

**Obsługa**, patrz rys. 9 na stronie 10**Konserwacja**, patrz rys. 10 na stronie 10

Montaż w odwrotnej kolejności.  
– Moment obrotowy dokręcenia nakrętki głowicy: 20-30 Nm

**Części zamiennie z numerami zamówienia**, patrz strona 11

 Informacje dotyczące gwarancji dostępne są w dołączonej **karcie pielęgnacyjno-gwarancyjnej**.



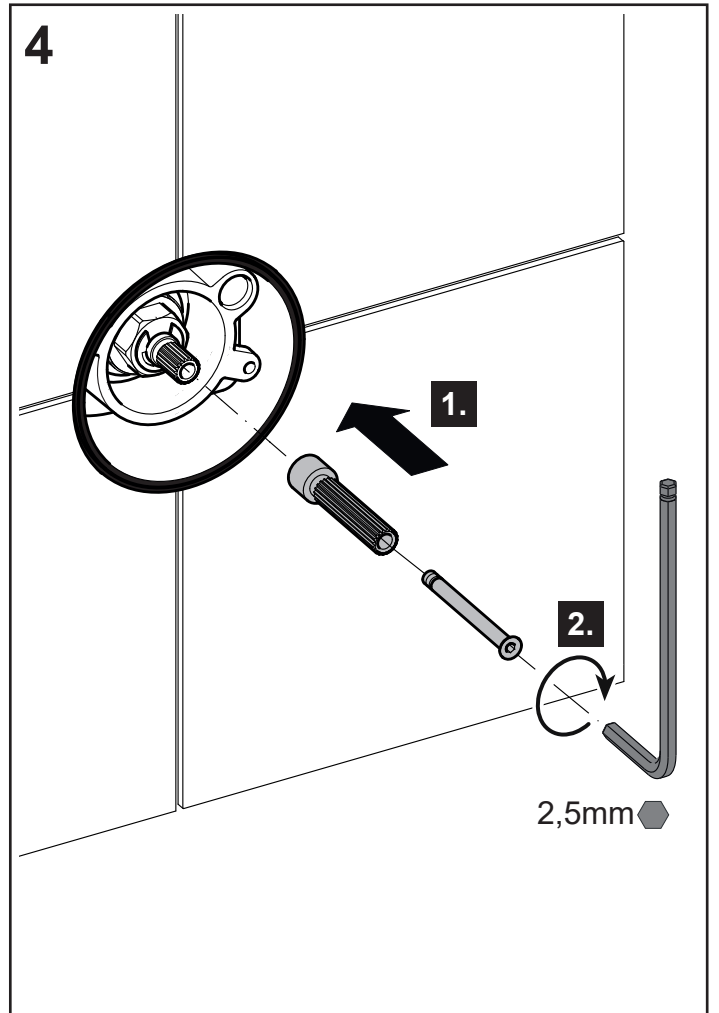
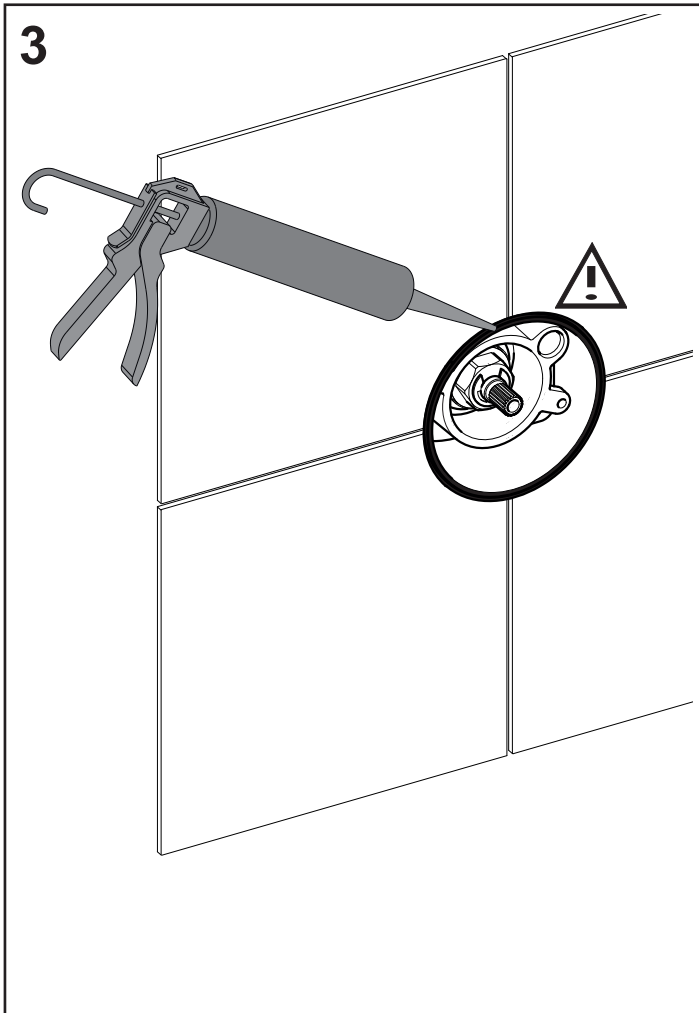
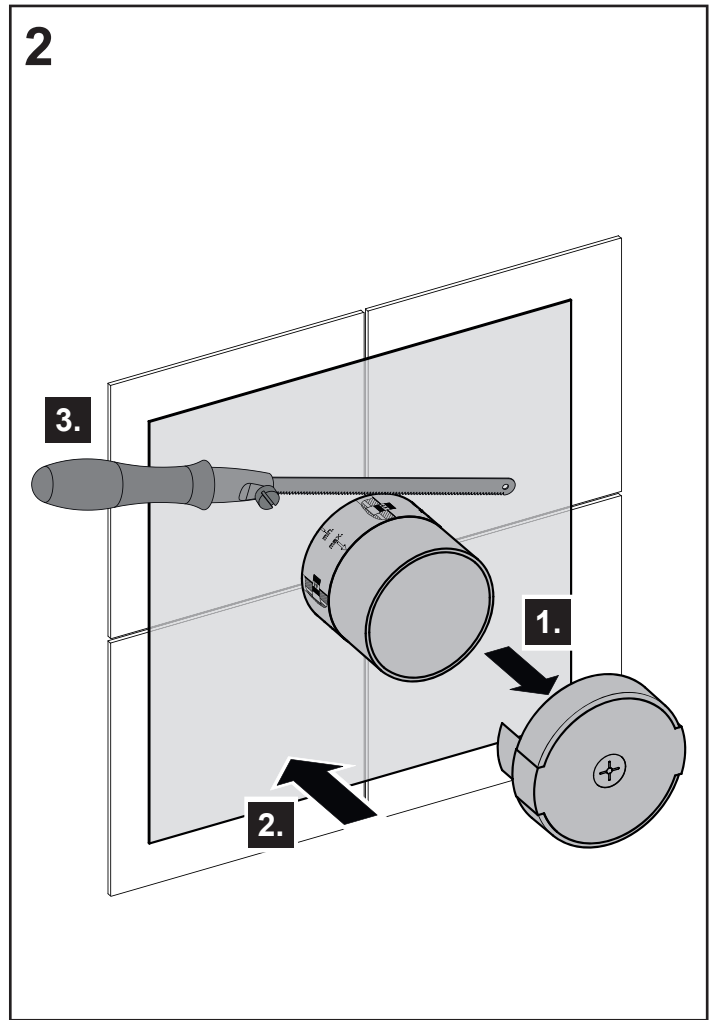
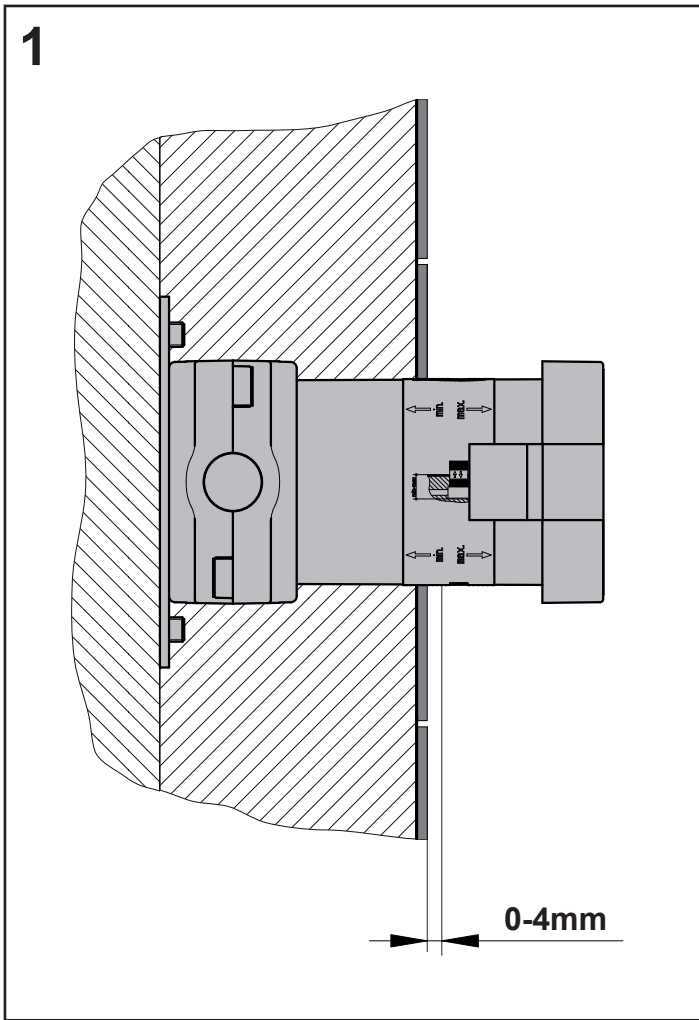

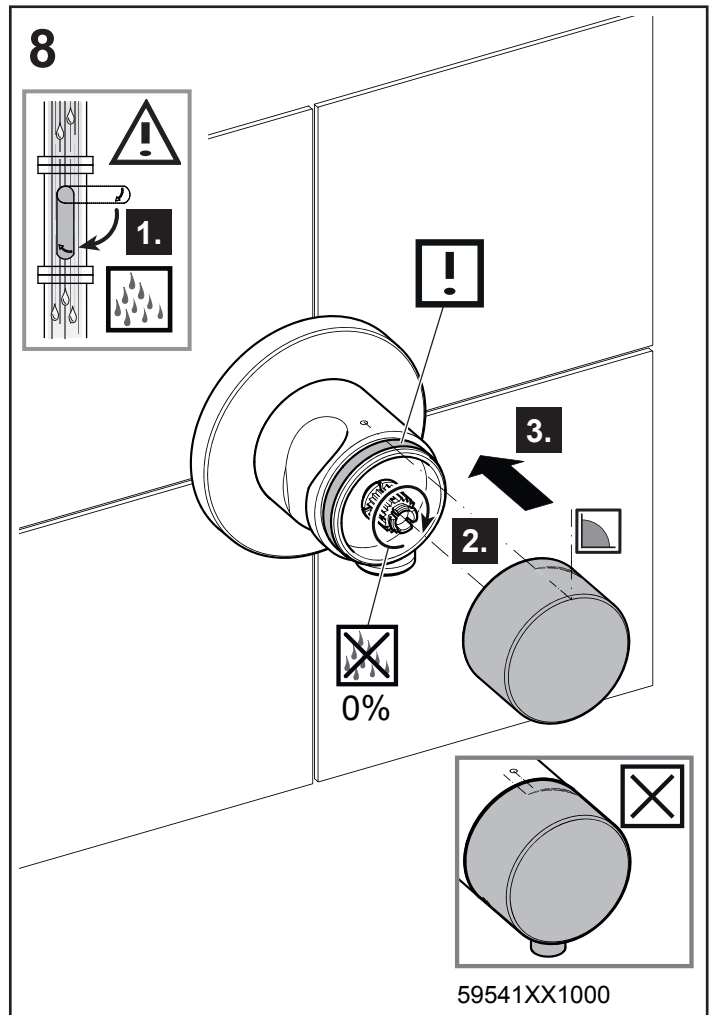
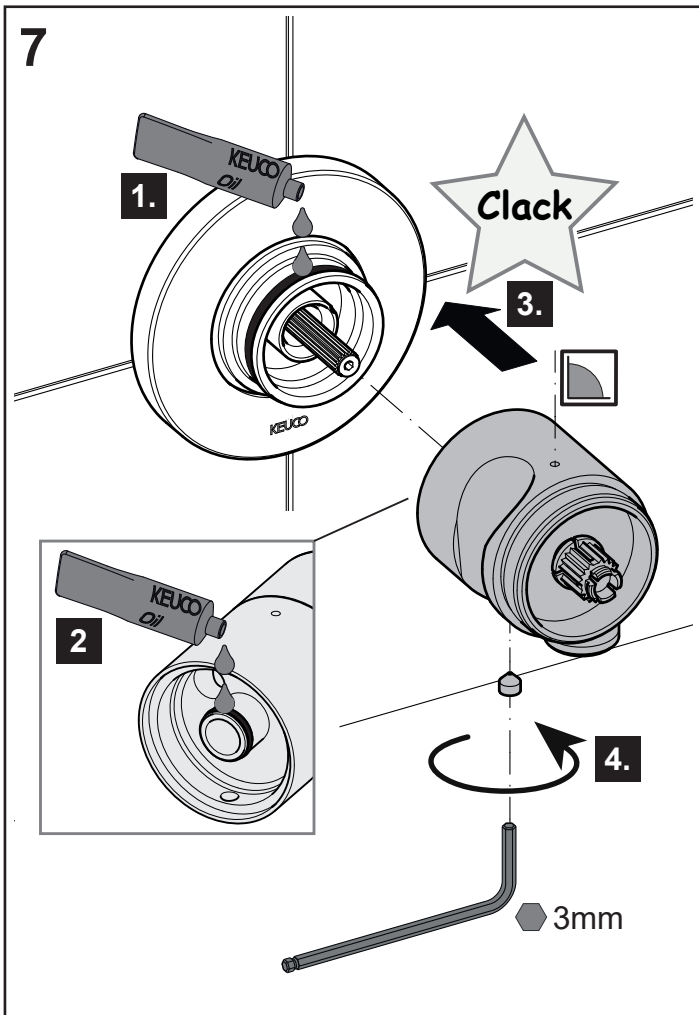
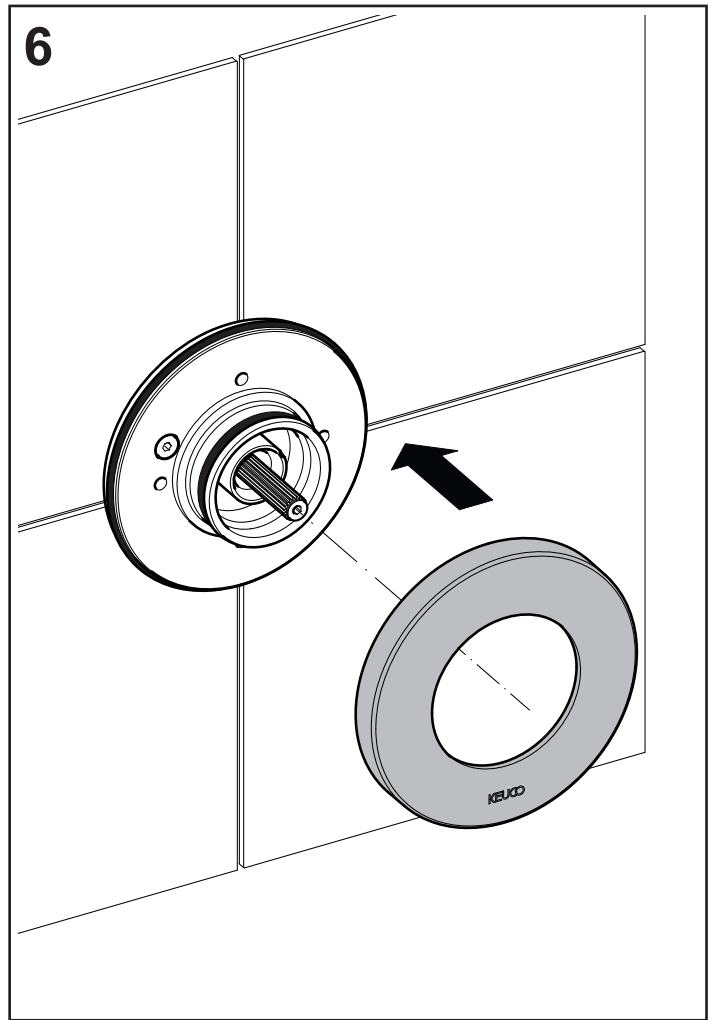
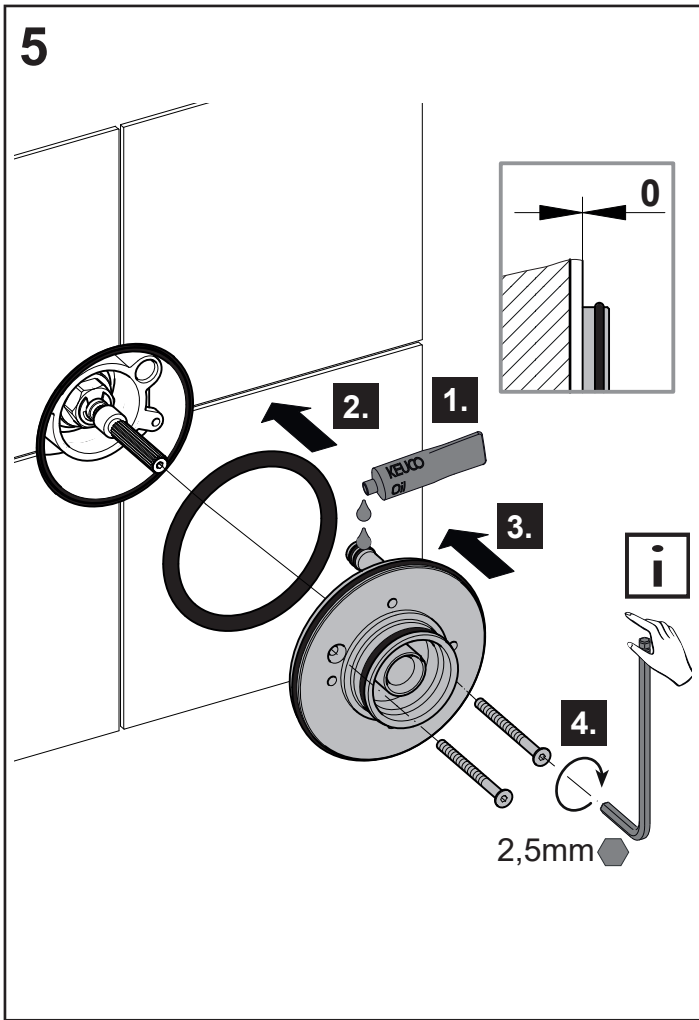

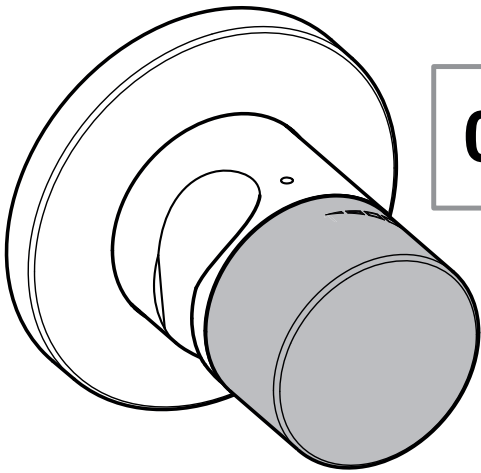

9

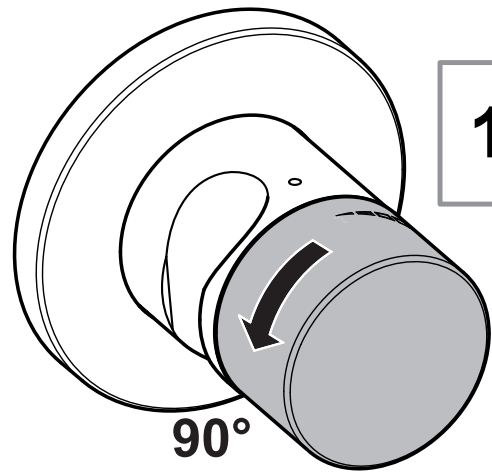

0   
0%



1   
100%

10

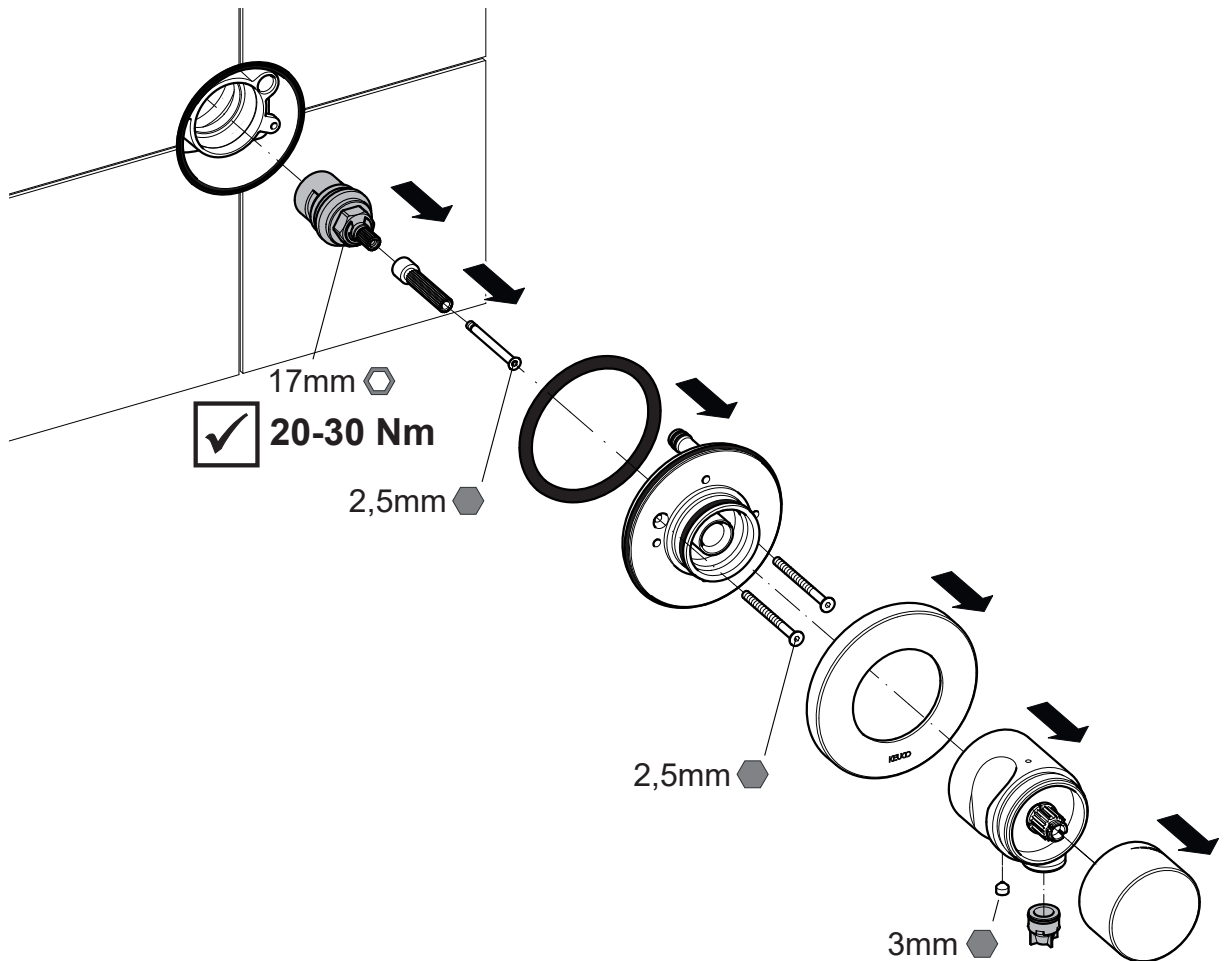

DE Ersatzteile

FR Pièces de rechange

CS Náhradní díly

EN Spare parts

IT Ricambi

PL Części zamienne

ES Piezas de recambio

NL Reserveonderdelen

RU Запчасти

59541 XX0201 59541 XX0202

59541 XX1201 59541 XX1202

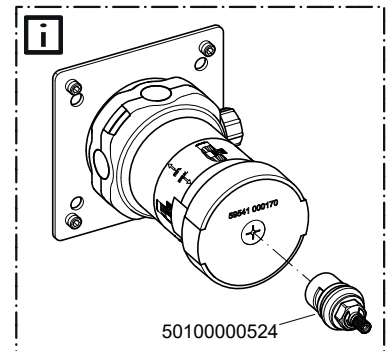
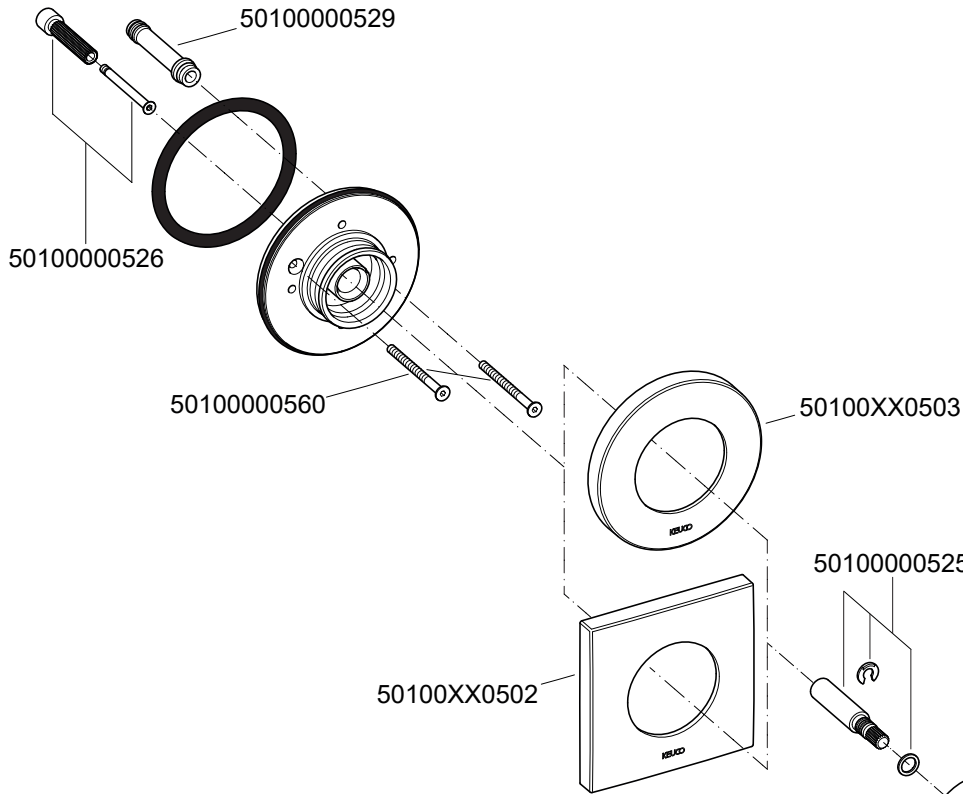

59541000170

**+** 59556XX0091

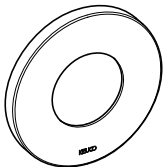

**+** 59551XX0281

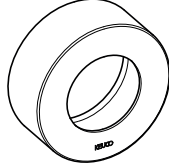

**+** 59556XX0092

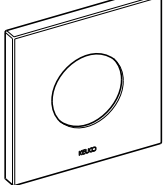

**+** 59551XX0282

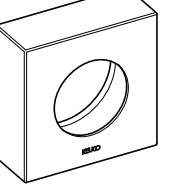

**+** 59556000171

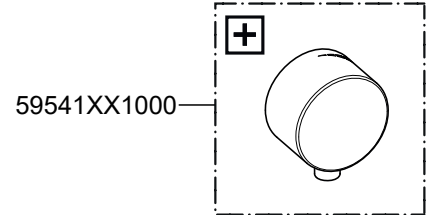
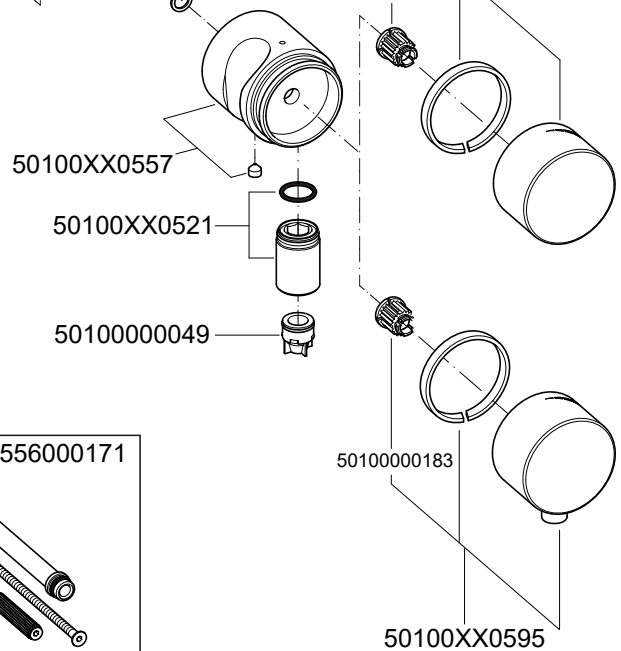
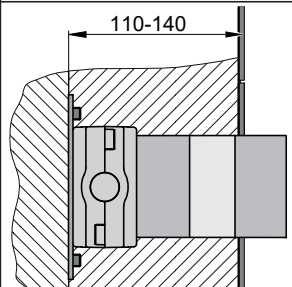
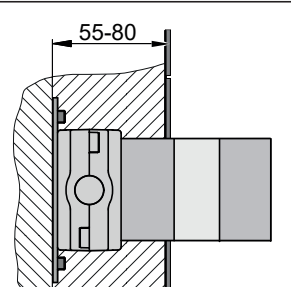
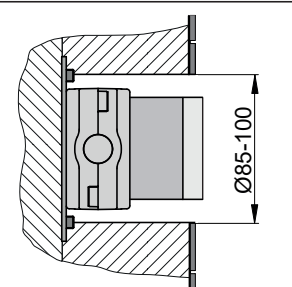
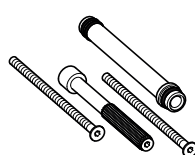

XX = 01, 03, 05, 07, 13, 17, 37

